

RENHOTECH GROUP

EV CHARGER CONNECTOR
EV HIGH-PERFORMANCE CONNECTOR

**EV充电接口
EV高性能连接器**



contents

目录

GB 标准交直流充电接口	GB standards AC and DC charging connector	04~22
IEC 标准交流充电接口	IEC standards AC charging connector	23~30
SAE 标准交流充电接口	SAE standards AC charging connector	31~34
企标交流充电接口	Enterprise standards AC charging connector	35~40
充电模式 2	Charging mode 2	41~50
充电模式 3	Charging mode 3	51~60
电锁	Electromagnetic lock	61~66
插头固定座	Plug dummy socket	67~67

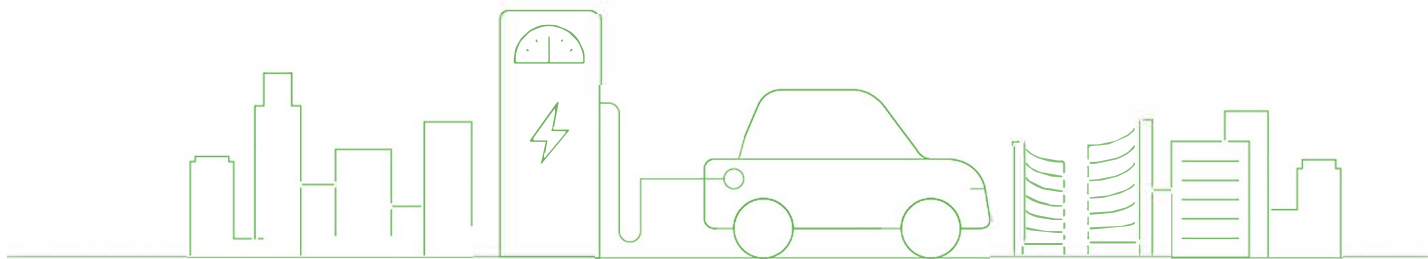

EV Conductive Charging Connection Device Option Guide EV传导充电连接装置选型引导

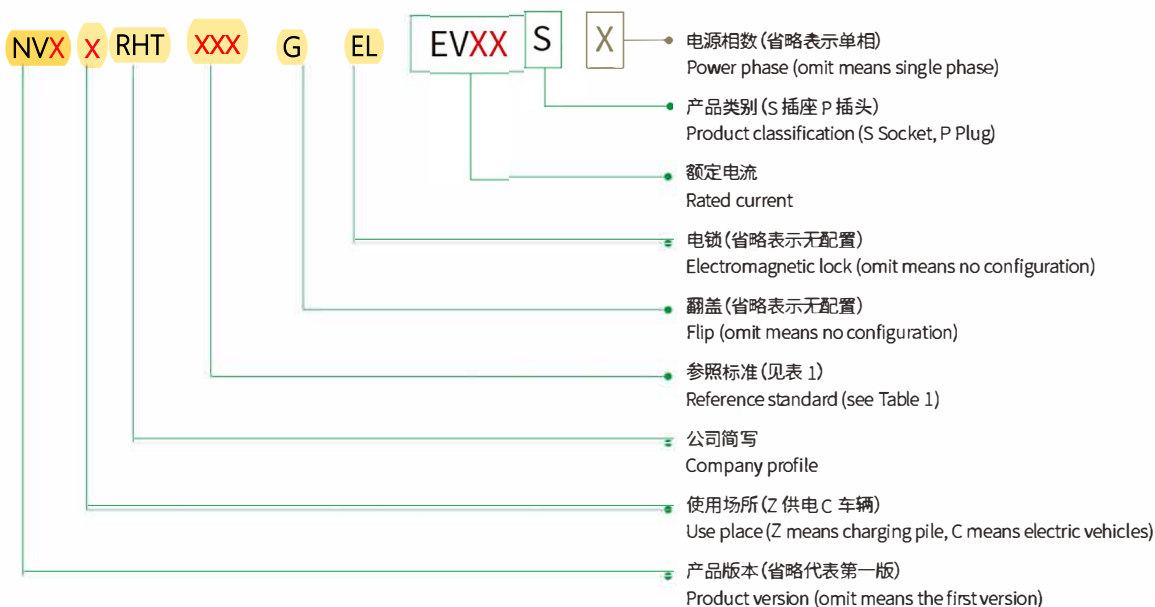

EV Conductive Charging Connection Device Reference Standards EV传导充电用连接装置参照标准

(表 1)

编号 / Serial No.	参照标准 / Reference standards
I	《电动汽车传导充电用连接装置》 《EV conductive charging connection device》 20234.2-2015
RHT	《电动汽车传导充电用连接装置》 《EV conductive charging connection device》 20234.3-2015
RHT	SAE J1772-2010
IEC2a	62196-2 IEC 2010 标准表格 (standards table)2-IIa
IEC2b	62196-2 IEC 2010 标准表格 (standards table)2-IIb
IEC2e	62196-2 IEC 2010 标准表格 (standards table)2-IIe
IEC2f	62196.2 IEC 2010 标准表格 (standards table)2-IIf

AC CHARGING PLUG 交流充电插头

产品应用: 充电桩端电连接输入
Product application: Charging pile electrical connection

型号 Model:

- NV2Z-RH T-EV10P
- NV2Z-RH T-EV16P
- NV2Z-RH T-EV32P

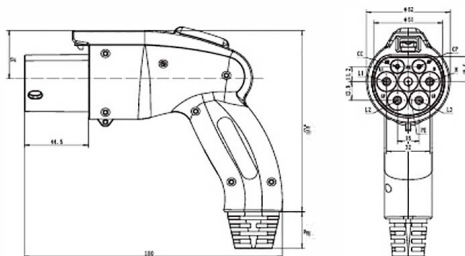

快速代码 Speed code: 1040

产品特点 Features

- 符合 GB/T 20234.2-2015 规定及要求
Meet GB/T 20234.2-2015 regulations and requirements
- 外形美观,手持式设计符合人体工程学原理,插拔便捷
Nice appearance, hand-held ergonomic design, easy plug

机械性能 Mechanical properties

- 机械寿命: 空载拔插 > 10000 次
Mechanical life: no-load plug in/pull out > 10000 times
- 抗冲击力: 可承受 1 米高度跌落与 2 吨车辆碾压压力
Impact of external force: can afford 1m drop and 2t vehicle run over pressure

环境性能 Environmental performance

- 工作环境温度: -30°C ~ +50°C
Operating temperature: -30°C ~ +50°C

材料应用 Applied Materials

- 外壳材料: 热塑性塑料,阻燃等级 UL94 V-0
Case Material: Thermoplastic, flame retardant grade UL94 V-0
- 插针: 铜合金,表面镀银 + 顶部热塑性塑料
Pin: Copper alloy, silver + thermoplastic on the top

- 插针头部采用安全绝缘设计,防止人手意外直接接触
Safety pins insulated head design to prevent accidental direct contact with staff
- 优越防护性能,防护等级达到 IP55(工作状态)
Excellent protection performance, protection grade IP55 (working condition)

电气性能 Electrical Performance

- 额定工作电流: 10A、16A 或 32A
Rated current: 10A, 16A or 32A
- 工作电压: 250V 或 440V
Operation voltage: 250V or 440V
- 绝缘电阻: > 1000MΩ (DC500V)
Insulation resistance: > 1000MΩ (DC500V)
- 端子温升: < 50K
Terminal temperature rise: < 50K
- 耐压: 2000V
Withstand Voltage: 2000V
- 接触阻抗: 0.5mΩ Max
Contact Resistance: 0.5mΩ Max

产品选型与标准配线 Model selection and the standard wiring

型号 / Model	额定电流 / Rated current	线缆规格 / Cable specification
NV2Z-RH T-EV10P	10A	3 X 2.5mm ² + 2 X 0.75mm ²
NV2Z-RH T-EV16P	16A 单相 / Single phase	3 X 2.5mm ² + 2 X 0.75mm ²
NV2Z-RH T-EV16P	16A 三相 / Three phase	5 X 2.5mm ² + 2 X 0.75mm ²
NV2Z-RH T-EV32P	32A 单相 / Single phase	3 X 6mm ² + 2 X 0.75mm ²
NV2Z-RH T-EV32P	32A 三相 / Three phase	5 X 6mm ² + 2 X 0.75mm ²

AC CHARGING PLUG 交流充电插头

产品应用: 电动汽车端电连接输入
Product application: Electric vehicle electrical connection

型号 Model:

- NV2C-RH T-EV10P
- NV2C-RH T-EV16P
- NV2C-RH T-EV32P

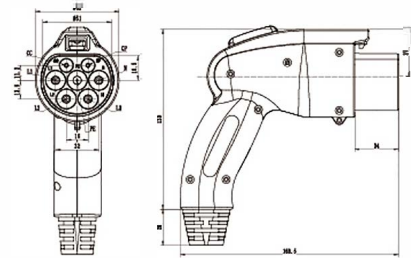

快速代码 Speed code: 1060

产品特点 Features

- 符合 GB/T 20234.2-2015 规定及要求
Meet GB/T 20234.2-2015 regulations and requirements
- 外形美观,手持式设计符合人体工程学原理,插拔便捷
Nice appearance, hand-held ergonomic design, easy plug

机械性能 Mechanical properties

- 机械寿命: 空载拔插 > 10000 次
Mechanical life: no-load plug in/pull out > 10000 times
- 抗冲击力: 可承受 1 米高度跌落与 2 吨车辆碾压力
Impact of external force: can afford 1m drop and 2t vehicle run over pressure

环境性能 Environmental performance

- 工作环境温度: -30°C ~ +50°C
Operating temperature: -30°C ~ +50°C

材料应用 Applied Materials

- 外壳材料: 热塑性塑料,阻燃等级 UL94 V-0
Case Material: Thermoplastic, flame retardant grade UL94 V-0
- 插针: 铜合金,表面镀银 + 顶部热塑性塑料
Pin: Copper alloy, silver + thermoplastic on the top

- 插针头部采用安全绝缘设计,防止人手意外直接接触
Safety pins insulated head design to prevent accidental direct contact with staff
- 优越防护性能,防护等级达到 IP55(工作状态)
Excellent protection performance, protection grade IP55 (working condition)

电气性能 Electrical Performance

- 额定工作电流: 10A、16A 或 32A
Rated current: 10A, 16A or 32A
- 工作电压: 250V 或 440V
Operation voltage: 250V or 440V
- 绝缘电阻: > 1000MΩ (DC500V)
Insulation resistance: > 1000MΩ (DC500V)
- 端子温升: < 50K
Terminal temperature rise: < 50K
- 耐压: 2000V
Withstand Voltage: 2000V
- 接触阻抗: 0.5mΩ Max
Contact Resistance: 0.5mΩ Max

产品选型与标准配线 Model selection and the standard wiring

型号 / Model	额定电流 / Rated current	线缆规格 / Cable specification
NV2C-RH T-EV10P	10A	3 X 2.5mm ² + 2 X 0.75mm ²
NV2C-RH T-EV16P	16A 单相 / Single phase	3 X 2.5mm ² + 2 X 0.75mm ²
NV2C-RH T-EV16P	16A 三相 / Three phase	5 X 2.5mm ² + 2 X 0.75mm ²
NV2C-RH T-EV32P	32A 单相 / Single phase	3 X 6mm ² + 2 X 0.75mm ²
NV2C-RH T-EV32P	32A 三相 / Three phase	5 X 6mm ² + 2 X 0.75mm ²

AC CHARGING PLUG 交流充电插头

产品应用: 充电桩端电连接输入
Product application: Charging pile electrical connection

型号 Model:

- NV3Z-RH T-EV10P
- NV3Z-RH T-EV16P
- NV3Z-RH T-EV32P

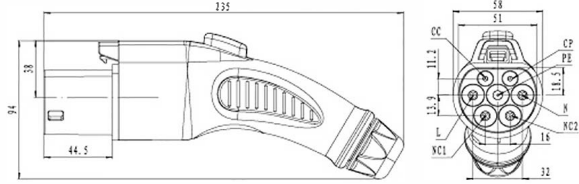

快速代码 Speed code: 1080

产品特点 Features

- 符合 GB/T 20234.2-2015 规定及要求
Meet GB/T 20234.2-2015 regulations and requirements
- 外形美观, 手持式设计符合人体工程学原理, 插拔便捷
Nice appearance, hand-held ergonomic design, easy plug
- 插头头部采用安全绝缘设计, 防止人手意外直接接触
Safety pins insulated head design to prevent accidental direct contact with staff
- 卓越防护性能, 防护等级达到 IP55 (工作状态)
Excellent protection performance, protection grade IP55 (working condition)

机械性能 Mechanical properties

- 机械寿命: 空载拔插 > 10000 次
Mechanical life: no-load plug in/pull out > 10000 times
- 抗冲击力: 可承受 1 米高度跌落与 2 吨车辆碾压力
Impact of external force: can afford 1m drop and 2t vehicle run over pressure

环境性能 Environmental performance

- 工作环境温度: -30°C ~ +50°C
Operating temperature: -30°C ~ +50°C

材料应用 Applied Materials

- 外壳材料: 热塑性塑料, 阻燃等级 UL94V-0
Case Material: Thermoplastic, flame retardant grade UL94V-0
- 插针: 铜合金, 表面镀银 + 顶部热塑性塑料
Pin: Copper alloy, silver + thermoplastic on the top

电气性能 Electrical Performance

- 额定工作电流: 10A、16A 或 32A
Rated current: 10A, 16A or 32A
- 工作电压: 250V 或 440V
Operation voltage: 250V or 440V
- 绝缘电阻: > 1000MΩ (DC500V)
Insulation resistance: > 1000MΩ (DC500V)
- 端子温升: < 50K
Terminal temperature rise: < 50K
- 耐压: 2000V
Withstand Voltage: 2000V
- 接触阻抗: 0.5mΩ Max
Contact Resistance: 0.5mΩ Max

产品选型与标准配线 Model selection and the standard wiring

型号 /Model	额定电流 /Rated current	线缆规格 /Cable specification
NV3Z-RH T-EV10P	10A	3 X 2.5mm ² + 2 X 0.75mm ²
NV3Z-RH T-EV16P	16A 单相 / Single phase	3 X 2.5mm ² + 2 X 0.75mm ²
	16A 三相 / Three phase	5 X 2.5mm ² + 2 X 0.75mm ²
NV3Z-RH T-EV32P	32A 单相 / Single phase	3 X 6mm ² + 2 X 0.75mm ²

AC CHARGING SOCKET

交流充电插座

产品应用: 充电桩端电连接输入
Product application: Charging pile electrical connection

型号 Model:

- NV3Z-RHT-GEL-EV16S
- NV3Z-RHT-GEL-EV32S

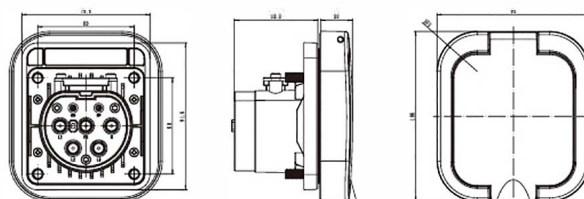

快速代码 Speed code: 1090

产品特点 Features

- 符合 GB/T 20234.2-2015 规定及要求
Meet GB/T 20234.2-2015 regulations and requirements
- 外形美观, 上翻盖防护, 支持后安装方式
Nice appearance, up flip protection, support back installation

机械性能 Mechanical properties

- 机械寿命: 空载拔插 > 10000 次
Mechanical life: no-load plug in/pull out > 10000 times
- 耦合时插拔力: > 45N < 80N
Coupled insertion force: > 45N < 80N

环境性能 Environmental performance

- 工作环境温度: -30°C ~ +50°C
Operating temperature: -30°C ~ +50°C

材料应用 Applied Materials

- 外壳材料: 热塑性塑料, 阻燃等级 UL94 V-0
Case Material: Thermoplastic, flame retardant grade UL94 V-0
- 插套: 铜合金, 表面镀银
Contact bush: Copper alloy, silver plating

- 可靠性材料, 阻燃、耐压、耐磨、耐冲击、高抗油
Reliability of materials, antifracking, pressure-resistant, abrasion resistance, impact resistance and high oil
- 优越防护性能, 防护等级达到 IP55 (工作状态)
Excellent protection performance, protection grade IP55 (working condition)

电气性能 Electrical Performance

- 额定工作电流: 16A 或 32A
Rated current: 16A or 32A
- 工作电压: 250V 或 440V
Operation voltage: 250V or 440V
- 绝缘电阻: > 1000MΩ (DC500V)
Insulation resistance: > 1000MΩ (DC500V)
- 端子温升: < 50K
Terminal temperature rise: < 50K
- 耐压: 2000V
Withstand Voltage: 2000V
- 接触阻抗: 0.5mΩ Max
Contact Resistance: 0.5mΩ Max

产品选型与标准配线 Model selection and the standard wiring

型号 / Model	额定电流 / Rated current	线缆规格 / Cable specification
NV3Z-RHT-GEL-EV16S	16A 单相 / Single phase	3 X 2.5mm ² + 2 X 0.75mm ²
	16A 三相 / Three phase	5 X 2.5mm ² + 2 X 0.75mm ²
NV3Z-RHT-GEL-EV32S	32A 单相 / Single phase	3 X 6mm ² + 2 X 0.75mm ²
	32A 三相 / Three phase	5 X 6mm ² + 2 X 0.75mm ²

AC CHARGING PLUG 交流充电插头

产品应用: 电动汽车端电连接输入
Product application: Electric vehicle electrical connection

型号 Model:

- NV3C-RHt-EV10P
- NV3C-RHt-EV16P
- NV3C-RHt-EV32P

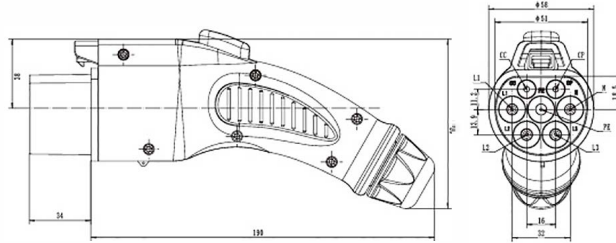

快速代码 Speed code: 1100

产品特点 Features

- 符合 GB/T 20234.2-2015 规定及要求
Meet GB/T 20234.2-2015 regulations and requirements
- 外形美观, 手持式设计符合人体工程学原理, 插拔便捷
Nice appearance, hand-held ergonomic design, easy plug
- 插头头部采用安全绝缘设计, 防止人手意外直接接触
Safety pins insulated head design to prevent accidental direct contact with staff
- 优越防护性能, 防护等级达到 IP55 (工作状态)
Excellent protection performance, protection grade IP55 (working condition)

机械性能 Mechanical properties

- 机械寿命: 空载拔插 > 10000 次
Mechanical life: no-load plug in/pull out > 10000 times
- 抗冲击力: 可承受 1 米高度跌落与 2 吨车辆碾压压力
Impact of external force: can afford 1m drop and 2t vehicle run over pressure

环境性能 Environmental performance

- 工作环境温度: -30°C ~ +50°C
Operating temperature: -30°C ~ +50°C

材料应用 Applied Materials

- 外壳材料: 热塑性塑料, 阻燃等级 UL94V-0
Case Material: Thermoplastic, flame retardant grade UL94V-0
- 插针: 铜合金, 表面镀银 + 顶部热塑性塑料
Pin: Copper alloy, silver + thermoplastic on the top

电气性能 Electrical Performance

- 额定工作电流: 10A、16A 或 32A
Rated current: 10A, 16A or 32A
- 工作电压: 250V 或 440V
Operation voltage: 250V or 440V
- 绝缘电阻: > 1000MΩ (DC500V)
Insulation resistance: > 1000MΩ (DC500V)
- 端子温升: < 50K
Terminal temperature rise: < 50K
- 耐压: 2000V
Withstand Voltage: 2000V
- 接触阻抗: 0.5mΩ Max
Contact Resistance: 0.5mΩ Max

产品选型与标准配线 Model selection and the standard wiring

型号 / Model	额定电流 / Rated current	线缆规格 / Cable specification
NV3C-RHt-EV10P	10A	3 X 2.5mm ²
NV3C-RHt-EV16P	16A 单相 / Single phase	3 X 2.5mm ² + 2 X 0.75mm ²
	16A 三相 / Three phase	5 X 2.5mm ² + 2 X 0.75mm ²
NV3C-RHt-EV32P	32A 单相 / Single phase	3 X 6mm ² + 2 X 0.75mm ²

AC CHARGING SOCKET

交流充电插座

产品应用: 电动汽车端电连接输入
Product application: Electric vehicle electrical connection

型号 Model:

- NV3C-RHT-G-EV16S
- NV3C-RHT-G-EV32S
- NV3C-RHT-G-EV63S

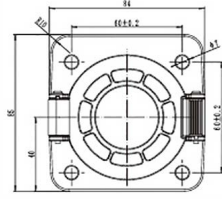
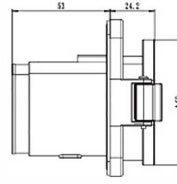
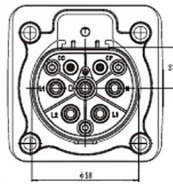

快速代码 Speed code: 1110

产品特点 Features

- 符合 GB/T 20234.2-2015 规定及要求
Meet GB/T 20234.2-2015 regulations and requirements
- 外形美观, 护盖可左右安装, 支持前安装方式
Nice appearance, flip can left and right installation, support front installation

机械性能 Mechanical properties

- 机械寿命: 空载拔插 > 10000 次
Mechanical life: no-load plug in/pull out > 10000 times
- 耦合时插拔力: > 45N < 80N
Coupled insertion force: > 45N < 80N

环境性能 Environmental performance

- 工作环境温度: -30°C ~ +50°C
Operating temperature: -30°C ~ +50°C

材料应用 Applied Materials

- 外壳材料: 热塑性塑料, 阻燃等级 UL94 V-0
Case Material: Thermoplastic, flame retardant grade UL94 V-0
- 插套: 铜合金, 表面镀银
Contact bush: Copper alloy, silver plating

- 可靠性材料, 阻燃、耐压、耐磨、耐冲击、高抗油
Reliability of materials, antifracking, pressure-resistant, abrasion resistance, impact resistance and high oil
- 优越防护性能, 防护等级达到 IP55 (工作状态)
Excellent protection performance, protection grade IP55 (working condition)

电气性能 Electrical Performance

- 额定工作电流: 16A 或 32A 或 63A
Rated current: 16A or 32A or 63A
- 工作电压: 250V 或 440V
Operation voltage: 250V or 440V
- 绝缘电阻: > 1000MΩ (DC500V)
Insulation resistance: > 1000MΩ (DC500V)
- 端子温升: < 50K
Terminal temperature rise: < 50K
- 耐压: 2000V
Withstand Voltage: 2000V
- 接触阻抗: 0.5mΩ Max
Contact Resistance: 0.5mΩ Max

产品选型与标准配线 Model selection and the standard wiring

型号 / Model	额定电流 / Rated current	线缆规格 / Cable specification
NV3C-RHT-G-EV16S	16A 单相 / Single phase	3 X 2.5mm ² + 2 X 0.75mm ²
	16A 三相 / Three phase	5 X 2.5mm ² + 2 X 0.75mm ²
NV3C-RHT-G-EV32S	32A 单相 / Single phase	3 X 6mm ² + 2 X 0.75mm ²
	32A 三相 / Three phase	5 X 6mm ² + 2 X 0.75mm ²
NV3C-RHT-G-EV63S	63A 三相 / Three phase	5 X 16mm ² + 2 X 0.75mm ²

AC CHARGING PLUG 交流充电插头

产品应用: 充电桩端电连接输入
Product application: Charging pile electrical connection

型号 Model:

- NV4Z-RHt-EV32P
- NV4Z-RHt-EV63P

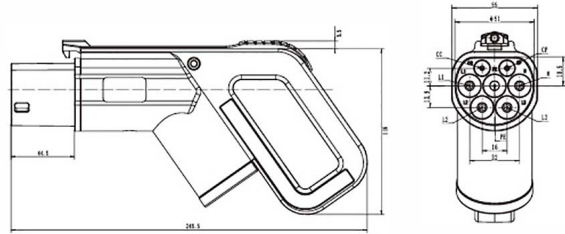

快速代码 Speed code: 1120

产品特点 Features

- 符合 GB/T 20234.2-2015 规定及要求
Meet GB/T 20234.2-2015 regulations and requirements
- 外形美观, 手持式设计符合人体工程学原理, 插拔便捷
Nice appearance, hand-held ergonomic design, easy plug

机械性能 Mechanical properties

- 机械寿命: 空载拔插 > 10000 次
Mechanical life: no-load plug in/pull out > 10000 times
- 抗冲击力: 可承受 1 米高度跌落与 2 吨车辆碾压力
Impact of external force: can afford 1m drop and 2t vehicle run over pressure

环境性能 Environmental performance

- 工作环境温度: -30°C ~ +50°C
Operating temperature: -30°C ~ +50°C

材料应用 Applied Materials

- 外壳材料: 热塑性塑料, 阻燃等级 UL94V-0
Case Material: Thermoplastic, flame retardant grade UL94V-0
- 插针: 铜合金, 表面镀银 + 顶部热塑性塑料
Pin: Copper alloy, silver + thermoplastic on the top

- 插头头部采用安全绝缘设计, 防止人手意外直接接触
Safety pins insulated head design to prevent accidental direct contact with staff
- 优越防护性能, 防护等级达到 IP55 (工作状态)
Excellent protection performance, protection grade IP55 (working condition)

电气性能 Electrical Performance

- 额定工作电流: 32A 或 63A
Rated current: 32A or 63A
- 工作电压: 250V 或 440V
Operation voltage: 250V or 440V
- 绝缘电阻: > 1000MΩ (DC500V)
Insulation resistance: > 1000MΩ (DC500V)
- 端子温升: < 50K
Terminal temperature rise: < 50K
- 耐压: 2000V
Withstand Voltage: 2000V
- 接触阻抗: 0.5mΩ Max
Contact Resistance: 0.5mΩ Max

产品选型与标准配线 Model selection and the standard wiring

型号 / Model	额定电流 / Rated current	线缆规格 / Cable specification
NV4Z-RHt-EV32P	32A 三相 / Three phase	5 X 6mm ² + 2 X 0.75mm ²
NV4Z-RHt-EV63P	63A 三相 / Three phase	5 X 16mm ² + 5 X 0.75mm ²

AC CHARGING SOCKET

交流充电插座

产品应用: 充电桩端电连接输入
Product application: Charging pile electrical connection

型号 Model:

- NV4Z-RHT-G-EV16S
- NV4Z-RHT-G-EV32S
- NV4Z-RHT-G-EV63S

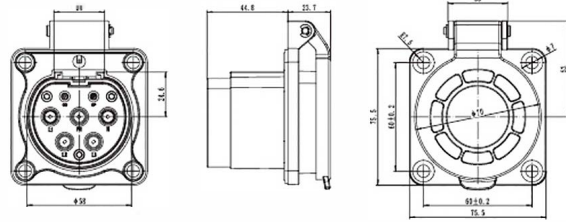

快速代码 Speed code: 1130

产品特点 Features

- 符合 GB/T 20234.2-2015 规定及要求
Meet GB/T 20234.2-2015 regulations and requirements
- 外形美观, 上翻盖防护, 支持前安装方式
Nice appearance, up flip protection, support front installation

机械性能 Mechanical properties

- 机械寿命: 空载拔插 > 10000 次
Mechanical life: no-load plugin/pull out > 10000 times
- 耦合时插拔力: > 45N < 80N
Coupled insertion force: > 45N < 80N

环境性能 Environmental performance

- 工作环境温度: -30°C ~ +50°C
Operating temperature: -30°C ~ +50°C

材料应用 Applied Materials

- 外壳材料: 热塑性塑料, 阻燃等级 UL94 V-0
Case Material: Thermoplastic, flame retardant grade UL94 V-0
- 插套: 铜合金, 表面镀银
Contact bush: Copper alloy, silver plating

- 可靠性材料, 阻燃、耐压、耐磨、耐冲击、高抗油
Reliability of materials, antifracking, pressure-resistant, abrasion resistance, impact resistance and high oil
- 优越防护性能, 防护等级达到 IP55 (工作状态)
Excellent protection performance, protection grade IP55 (working condition)

电气性能 Electrical Performance

- 额定工作电流: 16A 或 32A 或 63A
Rated current: 16A or 32A or 63A
- 工作电压: 250V 或 440V
Operation voltage: 250V or 440V
- 绝缘电阻: > 1000MΩ (DC500V)
Insulation resistance: > 1000MΩ (DC500V)
- 端子温升: < 50K
Terminal temperature rise: < 50K
- 耐压: 2000V
Withstand Voltage: 2000V
- 接触阻抗: 0.5mΩ Max
Contact Resistance: 0.5mΩ Max

产品选型与标准配线 Model selection and the standard wiring

型号 / Model	额定电流 / Rated current	线缆规格 / Cable specification
NV4Z-RHT-G-EV16S	16A	3 X 2.5mm ² + 2 X 0.75mm ²
	16A 三相 / Three phase	5 X 2.5mm ² + 2 X 0.75mm ²
NV4Z-RHT-G-EV32S	32A 单相 / Single phase	3 X 6mm ² + 2 X 0.75mm ²
	32A 三相 / Three phase	5 X 6mm ² + 2 X 0.75mm ²
NV4Z-RHT-G-EV63S	63A 三相 / Three phase	5 X 16mm ² + 2 X 0.75mm ²

AC CHARGING PLUG 交流充电插头

产品应用: 电动汽车端电连接输入
Product application: Electric vehicle connection

型号 Model:

● NV4C-RHT-EV32P

● NV4C-RHT-EV63P

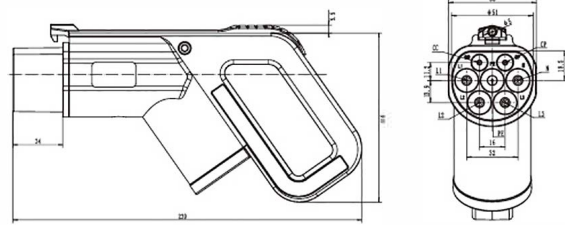

快速代码 Speed code: 1140

产品特点 Features

- 符合 GB/T 20234.2-2015 规定及要求
Meet GB/T 20234.2-2015 regulations and requirements
- 外形美观, 手持式设计符合人体工程学原理, 插拔便捷
Nice appearance, hand-held ergonomic design, easy plug

机械性能 Mechanical properties

- 机械寿命: 空载拔插 > 10000 次
Mechanical life: no-load plug in/pull out > 10000 times
- 抗冲击力: 可承受 1 米高度跌落与 2 吨车辆碾压力
Impact of external force: can afford 1m drop and 2t vehicle run over pressure

环境性能 Environmental performance

- 工作环境温度: -30°C ~ +50°C
Operating temperature: -30°C ~ +50°C

材料应用 Applied Materials

- 外壳材料: 热塑性塑料, 阻燃等级 UL94 V-0
Case Material: Thermoplastic, flame retardant grade UL94V-0
- 插针: 铜合金, 表面镀银 + 顶部热塑性塑料
Pin: Copper alloy, silver + thermoplastic on the top

- 插针头部采用安全绝缘设计, 防止人手意外直接接触
Safety pins insulated head design to prevent accidental direct contact with staff
- 优越防护性能, 防护等级达到 IP55 (工作状态)
Excellent protection performance, protection grade IP55 (working condition)

电气性能 Electrical Performance

- 额定工作电流: 32A 或 63A
Rated current: 32A or 63A
- 工作电压: 250V 或 440V
Operation voltage: 250V or 440V
- 绝缘电阻: >1000MΩ (DC500V)
Insulation resistance: >1000MΩ (DC500V)
- 端子温升: <50K
Terminal temperature rise: <50K
- 耐压: 2000V
Withstand Voltage: 2000V
- 接触阻抗: 0.5mΩ Max
Contact Resistance: 0.5mΩ Max

产品选型与标准配线 Model selection and the standard wiring

型号 / Model	额定电流 / Rated current	线缆规格 / Cable specification
NV4Z-RHT-EV32P	32A 三相 / Three phase	5 X 6mm ² + 2 X 0.75mm ²
NV4Z-RHT-EV63P	63A 三相 / Three phase	5 X 16mm ² + 5 X 0.75mm ²

AC CHARGING SOCKET

交流充电插座

产品应用: 电动汽车端电连接输入
Product application: Electric vehicle electrical connection

型号 Model:

- NV4C-RHT -G-EV16S
- NV4C-RHT G-EV32S
- NV4C-RHT -G-EV63S

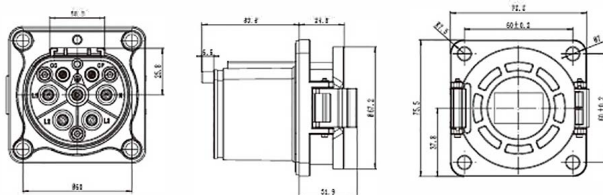

快速代码 Speed code: 1150

产品特点 Features

- 符合 GB/T 20234.2-2015 规定及要求
Meet GB/T 20234.2-2015 regulations and requirements
- 外形美观, 护盖可左右安装, 支持前安装方式
Nice appearance, flip can left and right installation, support front installation

机械性能 Mechanical properties

- 机械寿命: 空载拔插 > 10000 次
Mechanical life: no-load plugin/pull out > 10000 times
- 耦合时插拔力: > 45N < 80N
Coupled insertion force: > 45N < 80N

环境性能 Environmental performance

- 工作环境温度: -30°C ~ +50°C
Operating temperature: -30°C ~ +50°C

材料应用 Applied Materials

- 外壳材料: 热塑性塑料, 阻燃等级 UL94 V-0
Case Material: Thermoplastic, flame retardant grade UL94 V-0
- 插套: 铜合金, 表面镀银
Contact bush: Copper alloy, silver plating

- 可靠性材料, 阻燃、耐压、耐磨、耐冲击、高抗油
Reliability of materials, antifracking, pressure-resistant, abrasion resistance, impact resistance and high oil
- 优越防护性能, 防护等级达到 IP55 (工作状态)
Excellent protection performance, protection grade IP55 (working condition)

电气性能 Electrical Performance

- 额定工作电流: 16A 或 32A 或 63A
Rated current: 16A or 32A or 63A
- 工作电压: 250V 或 440V
Operation voltage: 250V or 440V
- 绝缘电阻: > 1000MΩ (DC500V)
Insulation resistance: > 1000MΩ (DC500V)
- 端子温升: < 50K
Terminal temperature rise: < 50K
- 耐压: 2000V
Withstand Voltage: 2000V
- 接触阻抗: 0.5mΩ Max
Contact Resistance: 0.5mΩ Max

产品选型与标准配线 Model selection and the standard wiring

型号 / Model	额定电流 / Rated current	线缆规格 / Cable specification
NV4C-RHT -G-EV16S	16A	3 X 2.5mm ² + 2 X 0.75mm ²
	16A 三相 / Three phase	5 X 2.5mm ² + 2 X 0.75mm ²
NV4C-RHT -G-EV32S	32A 单相 / Single phase	3 X 6mm ² + 2 X 0.75mm ²
	32A 三相 / Three phase	5 X 6mm ² + 2 X 0.75mm ²
NV4C-RHT -G-EV63S	63A 三相 / Three phase	5 X 16mm ² + 2 X 0.75mm ²

AC CHARGING PLUG 交流充电插头

产品应用: 充电桩端电连接输入
Product application: Charging pile electrical connection

型号 Model:

- V5Z-RHT-EV16P
- V5Z-RHT-EV32P

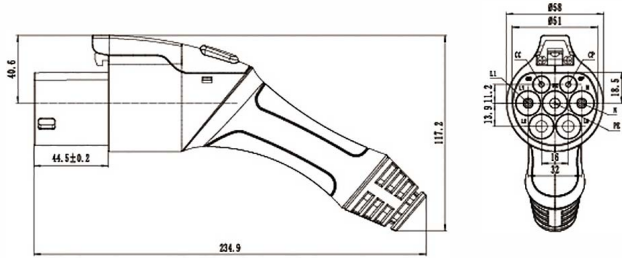
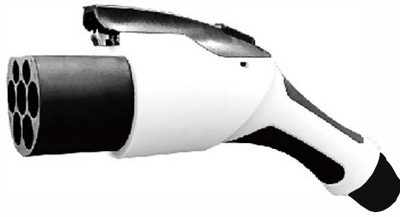

快速代码 Speed code: 1170

产品特点 Features

- 符合 GB/T 20234.2-2015 规定及要求
Meet GB/T 20234.2-2015 regulations and requirements
- 外形美观, 手持式设计符合人体工程学原理, 插拔便捷
Nice appearance, hand-held ergonomic design, easy plug

机械性能 Mechanical properties

- 机械寿命: 空载拔插 > 10000 次
Mechanical life: no-load plug in/pull out > 10000 times
- 抗冲击力: 可承受 1 米高度跌落与 2 吨车辆碾压力
Impact of external force: can afford 1m drop and 2t vehicle run over pressure

环境性能 Environmental performance

- 工作环境温度: -30°C ~ +50°C
Operating temperature: -30°C ~ +50°C

材料应用 Applied Materials

- 外壳材料: 热塑性塑料, 阻燃等级 UL94 V-0
Case Material: Thermoplastic, flame retardant grade UL94 V-0
- 插针: 铜合金, 表面镀银 + 顶部热塑性塑料
Pin: Copper alloy, silver + thermoplastic on the top

- 插针头部采用安全绝缘设计, 防止人手意外直接接触
Safety pins insulated head design to prevent accidental direct contact with staff
- 优越防护性能, 防护等级达到 IP55 (工作状态)
Excellent protection performance, protection grade IP55 (working condition)

电气性能 Electrical Performance

- 额定工作电流: 16A 或 32A
Rated current: 16A or 32A
- 工作电压: 250V
Operation voltage: 250V
- 绝缘电阻: > 1000MΩ (DC500V)
Insulation resistance: > 1000MΩ (DC500V)
- 端子温升: < 50K
Terminal temperature rise: < 50K
- 耐压: 2000V
Withstand Voltage: 2000V
- 接触阻抗: 0.5mΩ Max
Contact Resistance: 0.5mΩ Max

产品选型与标准配线 Model selection and the standard wiring

型号 / Model	额定电流 / Rated current	线缆规格 / Cable specification
V5Z-RHT-EV16P	16A	3 X 2.5mm ² + 2 X 0.75mm ²
V5Z-RHT-EV32P	32A	3 X 6mm ² + 2 X 0.75mm ²

AC CHARGING PLUG 交流充电插头

产品应用: 充电桩端电连接输入
Product application: Charging pile electrical connection

型号 Model:

● NV6Z-RHT-EV16P

● NV6Z-RHT-EV32P

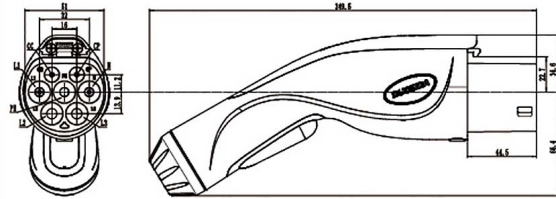
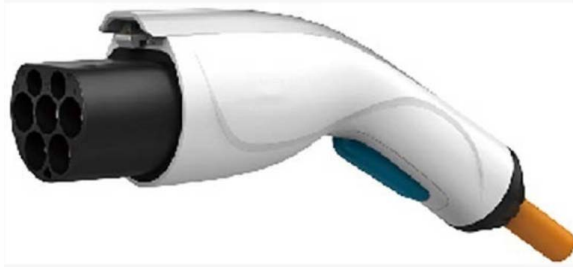

快速代码 Speed code: 1190

产品特点 Features

- 符合 GB/T 20234.2-2015 规定及要求
Meet GB/T 20234.2-2015 regulations and requirements
- 外形美观, 手持式设计符合人体工程学原理, 插拔便捷
Nice appearance, hand-held ergonomic design, easy plug

机械性能 Mechanical properties

- 机械寿命: 空载拔插 > 10000 次
Mechanical life: no-load plug in/pull out > 10000 times
- 抗冲击力: 可承受 1 米高度跌落与 2 吨车辆碾压力
Impact of external force: can afford 1m drop and 2t vehicle run over pressure

环境性能 Environmental performance

- 工作环境温度: -30°C ~ +50°C
Operating temperature: -30°C ~ +50°C

材料应用 Applied Materials

- 外壳材料: 热塑性塑料, 阻燃等级 UL94 V-0
Case Material: Thermoplastic, flame retardant grade UL94 V-0
- 插针: 铜合金, 表面镀银 + 顶部热塑性塑料
Pin: Copper alloy, silver + thermoplastic on the top

- 插针头部采用安全绝缘设计, 防止人手意外直接接触
Safety pins insulated head design to prevent accidental direct contact with staff
- 优越防护性能, 防护等级达到 IP66 (工作状态)
Excellent protection performance, protection grade IP66 (working condition)

电气性能 Electrical Performance

- 额定工作电流: 16A 或 32A
Rated current: 16A or 32A
- 工作电压: 250V
Operation voltage: 250V
- 绝缘电阻: > 1000MΩ (DC500V)
Insulation resistance: > 1000MΩ (DC500V)
- 端子温升: < 50K
Terminal temperature rise: < 50K
- 耐压: 2000V
Withstand Voltage: 2000V
- 接触阻抗: 0.5mΩ Max
Contact Resistance: 0.5mΩ Max

产品选型与标准配线 Model selection and the standard wiring

型号 / Model	额定电流 / Rated current	线缆规格 / Cable specification
NV6Z-RHT-EV16P	16A	3 X 2.5mm ² + 2 X 0.75mm ²
	16A 三相 / Threephase	5 X 2.5mm ² + 2 X 0.75mm ²
NV6Z-RHT-EV32P	32A 单相 / Single phase	3 X 6mm ² + 2 X 0.75mm ²

AC CHARGING PLUG 交流充电插头

产品应用: 电动汽车端电连接输入
Product application: Electric vehicle electrical connection

型号 Model:

● NV6C-RHT-EV16P

● NV6C-RHT-EV32P

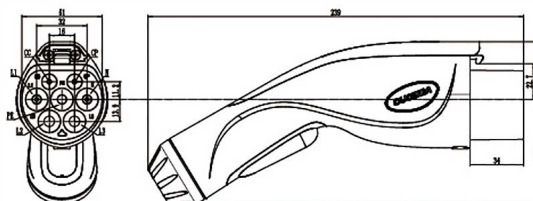
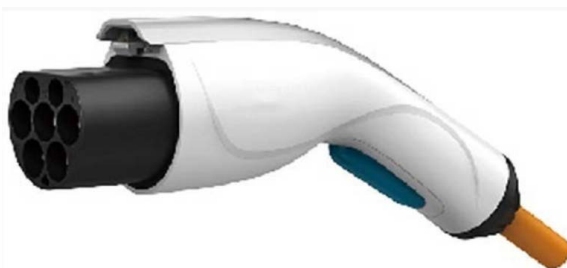

快速代码 Speed code: 1180

产品特点 Features

- 符合 GB/T 20234.2-2015 规定及要求
Meet GB/T 20234.2-2015 regulations and requirements
- 外形美观, 手持式设计符合人体工程学原理, 插拔便捷
Nice appearance, hand-held ergonomic design, easy plug

机械性能 Mechanical properties

- 机械寿命: 空载拔插 > 10000 次
Mechanical life: no-load plug in/pull out > 10000 times
- 抗冲击力: 可承受 1 米高度跌落与 2 吨车辆碾压力
Impact of external force: can afford 1m drop and 2t vehicle run over pressure

环境性能 Environmental performance

- 工作环境温度: -30°C ~ +50°C
Operating temperature: -30°C ~ +50°C

材料应用 Applied Materials

- 外壳材料: 热塑性塑料, 阻燃等级 UL94 V-0
Case Material: Thermoplastic, flame retardant grade UL94 V-0
- 插针: 铜合金, 表面镀银 + 顶部热塑性塑料
Pin: Copper alloy, silver + thermoplastic on the top

- 插针头部采用安全绝缘设计, 防止人手意外直接接触
Safety pins insulated head design to prevent accidental direct contact with staff
- 优越防护性能, 防护等级达到 IP66(工作状态)
Excellent protection performance, protection grade IP66(working condition)

电气性能 Electrical Performance

- 额定工作电流: 16A 或 32A
Rated current: 16A or 32A
- 工作电压: 250V
Operation voltage: 250V
- 绝缘电阻: > 1000MΩ (DC500V)
Insulation resistance: > 1000MΩ (DC500V)
- 端子温升: < 50K
Terminal temperature rise: < 50K
- 耐压: 2000V
Withstand Voltage: 2000V
- 接触阻抗: 0.5mΩ Max
Contact Resistance: 0.5mΩ Max

产品选型与标准配线 Model selection and the standard wiring

型号 / Model	额定电流 / Rated current	线缆规格 / Cable specification
NV6C-RHT-EV16P	16A	3 X 2.5mm ² + 2 X 0.75mm ²
	16A 三相 / Three phase	5 X 2.5mm ² + 2 X 0.75mm ²
NV6C-RHT-EV32P	32A 单相 / Single phase	3 X 6mm ² + 2 X 0.75mm ²

DC CHARGING PLUG 直流充电插头

产品应用: 电动汽车端电连接输入
Product application: Electric vehicle electrical connection

型号 Model:

- NV3-RHT-EV80P
- NV3-RHT-EV125P
- NV3-RHT-EV200P
- NV3-RHT-EV250P

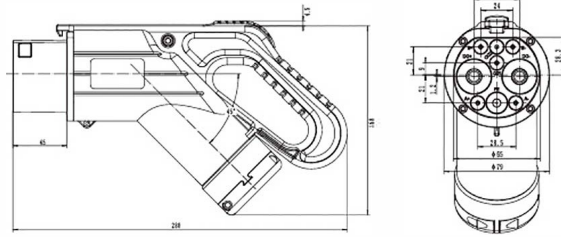

快速代码 Speed code: 1510

产品特点 Features

- 符合 GB/T 20234.3-2015 规定及要求
Meet GB/T 20234.3-2015 regulations and requirements
- 外形美观,手持式设计符合人体工程学原理,插拔便捷
Nice appearance, hand-held ergonomic design, easy plug
- 插针头部采用安全绝缘设计,防止人手意外直接接触
Safety pins insulated head design to prevent accidental direct contact with staff
- 优越防护性能,防护等级达到 IP55 (工作状态)
Excellent protection performance, protection grade IP55 (working condition)

机械性能 Mechanical properties

- 机械寿命: 空载拔插 > 10000 次
Mechanical life: no-load plug in/pull out > 10000 times
- 抗冲击力: 可承受 1 米高度跌落与 2 吨车辆碾压力
Impact of external force: can afford 1m drop and 2t vehicle run over pressure

环境性能 Environmental performance

- 工作环境温度: -30°C ~ +50°C
Operating temperature: -30°C ~ +50°C

材料应用 Applied Materials

- 外壳材料: 热塑性塑料, 阻燃等级 UL94V-0
Case Material: Thermoplastic, flame retardant grade UL94 V-0
- 插针: 铜合金, 表面镀银 + 顶部热塑性塑料
Pin: Copper alloy, silver + thermoplastic on the top

电气性能 Electrical Performance

- 额定工作电流: 80A 或 125A 或 200A 或 250A
Rated current: 80A or 125A or 200A or 250A
- 工作电压: 750V
Operation voltage: 750V
- 绝缘电阻: >2000MΩ (DC1000V)
Insulation resistance: >2000MΩ (DC1000V)
- 端子温升: <50K
Terminal temperature rise: <50K
- 耐压: 3000V
Withstand Voltage: 3000V
- 接触阻抗: 0.5mΩ Max
Contact Resistance: 0.5mΩ Max

产品选型与标准配线 Model selection and the standard wiring

型号 /Model	额定电流 /Rated current	线缆规格 /Cable specification
NV3-RHT-EV80P	80A	3 X 16mm ² + 2 X 4mm ² + 2P(4 X 0.75mm ²) + 2P(2 X 0.75mm ²)
NV3-RHT-EV125P	125A	2 X 35mm ² + 1 X 16mm ² + 2 X 4mm ² + 2P(4 X 0.75mm ²) + 2P(2 X 0.75mm ²)
NV3-RHT-EV200P	200A	2 X 70mm ² + 1 X 25mm ² + 2 X 4mm ² + 2P(4 X 0.75mm ²) + 2P(2 X 0.75mm ²)
NV3-RHT-EV250P	250A	2 X 80mm ² + 1 X 25mm ² + 2 X 4mm ² + 2P(4 X 0.75mm ²) + 2P(2 X 0.75mm ²)

DC CHARGING SOCKET

直流充电插座

产品应用: 电动汽车端电连接输入
Product application: Electric vehicle electrical connection

型号 Model:

- NV2-RHT-G-EV80S
- NV2-RHT-G-EV125S
- NV2-RHT-G-EV200S
- NV2-RHT-G-EV250S

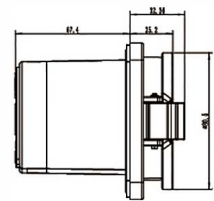
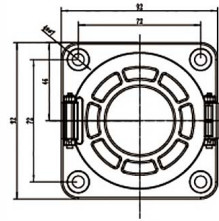

快速代码 Speed code: 1520

产品特点 Features

- 符合 GB/T 20234.3-2015 规定及要求
Meet GB/T 20234.3-2015 regulations and requirements
- 外形美观, 左开盖防护, 支持前安装方式
Nice appearance, left flip protection, support front installation

机械性能 Mechanical properties

- 机械寿命: 空载拔插 > 10000 次
Mechanical life: no-load plug in/pull out > 10000 times
- 耦合时插拔力: > 70N < 140N
Coupled insertion force: > 70N < 140N

环境性能 Environmental performance

- 工作环境温度: -30°C ~ +50°C
Operating temperature: -30°C ~ +50°C

材料应用 Applied Materials

- 外壳材料: 热塑性塑料, 阻燃等级 UL94 V-0
Case Material: Thermoplastic, flame retardant grade UL94 V-0
- 插套: 铜合金, 表面镀银
Contact bush: Copper alloy, silver plating

- 可靠性材料, 阻燃、耐压、耐磨、耐冲击、高抗油
Reliability of materials, antifracking, pressure-resistant, abrasion resistance, impact resistance and high oil
- 优越防护性能, 防护等级达到 IP55 (工作状态)
Excellent protection performance, protection grade IP55 (working condition)

电气性能 Electrical Performance

- 额定工作电流: 80A 或 125A 或 200A 或 250A
Rated current: 80A or 125A or 200A or 250A
- 工作电压: 750V
Operation voltage: 750V
- 绝缘电阻: > 2000MΩ (DC1000V)
Insulation resistance: > 2000MΩ (DC1000V)
- 端子温升: < 50K
Terminal temperature rise: < 50K
- 耐压: 3000V
Withstand Voltage: 3000V
- 接触阻抗: 0.5mΩ Max
Contact Resistance: 0.5mΩ Max

产品选型与标准配线 Model selection and the standard wiring

型号 /Model	额定电流 /Rated current	线缆规格 /Cable specification
NV2-DSD-G-EV80S	80A	3X 16mm ² + 2X 2.5mm ² + 4X 0.75mm ²
NV2-DSD-G-EV125S	125A	2X 35mm ² + 1X 16mm ² + 2X 2.5mm ² + 6X 0.75mm ²
NV2-DSD-G-EV200S	200A	2X 70mm ² + 1X 25mm ² + 2X 2.5mm ² + 4X 0.75mm ²
NV2-DSD-G-EV250S	250A	2X 80mm ² + 1X 25mm ² + 2X 2.5mm ² + 4X 0.75mm ²

AC CHARGING PLUG 交流充电插头

产品应用: 充电桩端电连接输入
Product application: Charging pile electrical connection

型号 Model:

- RHT EC2b-EV16P
- RHT EC2b-EV32P

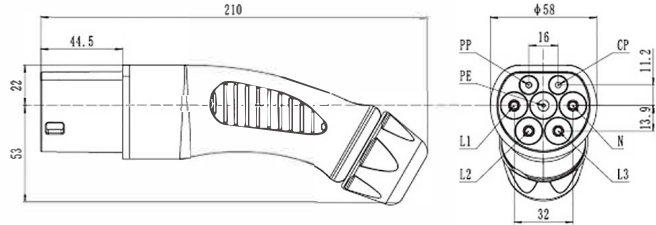

快速代码 Speed code: 2010

产品特点 Features

- 符合 62196-2 IEC 2010 SHEET 2-IIb 标准
Meet 62196-2 IEC 2010 SHEET 2-IIb standard
- 外形美观, 手持式设计符合人体工程学原理, 插拔便捷
Nice appearance, hand-held ergonomic design, easy plug

机械性能 Mechanical properties

- 机械寿命: 空载拔插 > 10000 次
Mechanical life: no-load plug in/pull out > 10000 times
- 抗冲击力: 可承受 1 米高度跌落与 2 吨车辆碾压力
Impact of external force: can afford 1m drop and 2t vehicle run over pressure

环境性能 Environmental performance

- 工作环境温度: -30°C ~ +50°C
Operating temperature: -30°C ~ +50°C

材料应用 Applied Materials

- 外壳材料: 热塑性塑料, 阻燃等级 UL94V-0
Case Material: Thermoplastic, flame retardant grade UL94 V-0
- 插针: 铜合金, 表面镀银 + 顶部热塑性塑料
Pin: Copper alloy, silver + thermoplastic on the top

- 插针头部采用安全绝缘设计, 防止人手意外直接接触
Safety pins insulated head design to prevent accidental direct contact with staff
- 优越防护性能, 防护等级达到 IP44 (工作状态)
Excellent protection performance, protection grade IP44 (working condition)

电气性能 Electrical Performance

- 额定工作电流: 16A 或 32A
Rated current: 16A or 32A
- 工作电压: 240/415V
Operation voltage: 240V or 415V
- 绝缘电阻: > 1000MΩ (DC500V)
Insulation resistance: > 1000MΩ (DC500V)
- 端子温升: < 50K
Terminal temperature rise: < 50K
- 耐压: 2000V
Withstand Voltage: 2000V
- 接触阻抗: 0.5mΩ Max
Contact Resistance: 0.5mΩ Max

产品选型与标准配线 Model selection and the standard wiring

型号 / Model	额定电流 / Rated current	线缆规格 / Cable specification
RHT EC2b-EV16P	16A 单相 / Single phase	3 X 2.5mm ² + 1 X 0.75mm ²
	16A 三相 / Three phase	5 X 2.5mm ² + 1 X 0.75mm ²
RHT EC2b-EV32P	32A 单相 / Single phase	3 X 6mm ² + 1 X 0.75mm ²
	32A 三相 / Three phase	5 X 6mm ² + 1 X 0.75mm ²

AC CHARGING SOCKET

交流充电插座

产品应用: 充电桩端电连接输入
Product application: Charging pile electrical connection

型号 Model:

● RHTEC2a-G-EV16S

● RHTEC2a-G-EV32S

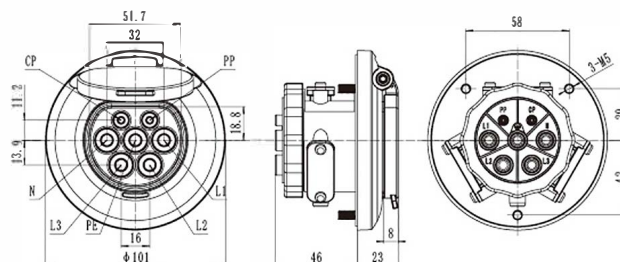

快速代码 Speed code: 2030

产品特点 Features

- 符合 62196-2 IEC 2010 SHEET 2-IIa 标准
Meet 62196-2 IEC 2010 SHEET 2-IIa standard
- 外形美观, 上翻盖防护, 支持前后安装方式
Nice appearance, up flip protection, support front and back installation

机械性能 Mechanical properties

- 机械寿命: 空载拔插 > 10000 次
Mechanical life: no-load plug in/pull out > 10000 times
- 耦合时插拔力: > 45N < 80N
Coupled insertion force: > 45N < 80N

环境性能 Environmental performance

- 工作环境温度: -30°C ~ +50°C
Operating temperature: -30°C ~ +50°C

材料应用 Applied Materials

- 外壳材料: 热塑性塑料, 阻燃等级 UL94V-0
Case Material: Thermoplastic, flame retardant grade UL94 V-0
- 插套: 铜合金, 表面镀银
Contact bush: Copper alloy, silver plating

- 可靠性材料, 阻燃、耐压、耐磨、耐冲击、高抗油
Reliability of materials, antiflaming, pressure-resistant, abrasion resistance, impact resistance and high oil
- 优越防护性能, 防护等级达到 IP44 (工作状态)
Excellent protection performance, protection grade IP44 (working condition)

电气性能 Electrical Performance

- 额定工作电流: 16A 或 32A
Rated current: 16A or 32A
- 工作电压: 240/415V
Operation voltage: 240/415V
- 绝缘电阻: > 1000MΩ (DC500V)
Insulation resistance: > 1000MΩ (DC500V)
- 端子温升: < 50K
Terminal temperature rise: < 50K
- 耐压: 2000V
Withstand Voltage: 2000V
- 接触阻抗: 0.5mΩ Max
Contact Resistance: 0.5mΩ Max

产品选型与标准配线 Model selection and the standard wiring

型号 / Model	额定电流 / Rated current	线缆规格 / Cable specification
RHTEC2a-G-EV16S	16A 单相 / Single phase	3 X 2.5mm ² + 2 X 0.75mm ²
	16A 三相 / Three phase	5 X 2.5mm ² + 2 X 0.75mm ²
RHTEC2a-G-EV32S	32A 单相 / Single phase	3 X 6mm ² + 2 X 0.75mm ²
	32A 三相 / Three phase	5 X 6mm ² + 2 X 0.75mm ²

AC CHARGING PLUG 交流充电插头

产品应用: 电动汽车端电连接输入
Product application: Electric vehicle electrical connection

型号 Model:

- RHTEC2e-EV16P
- RHTEC2e-EV32P

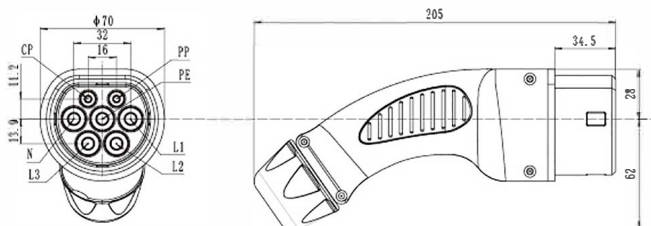

快速代码 Speed code: 2050

产品特点 Features

- 符合 62196-2 IEC 2010 SHEET 2-IIe 标准
Meet 62196-2 IEC 2010 SHEET 2-IIe standard
- 外形美观, 手持式设计符合人体工程学原理, 插拔便捷
Nice appearance, hand-held ergonomic design, easy plug

机械性能 Mechanical properties

- 机械寿命: 空载插拔 > 10000 次
Mechanical life: no-load plug in/pull out > 10000 times
- 耦合时插拔力: > 45N < 80N
Coupled insertion force: > 45N < 80N
- 抗冲击力: 可承受 1 米高度跌落与 2 吨车辆碾压力
Impact of external force: can afford 1m drop and 2t vehicle run over pressure

环境性能 Environmental performance

- 工作环境温度: -30°C ~ +50°C
Operating temperature: -30°C ~ +50°C

材料应用 Applied Materials

- 外壳材料: 热塑性塑料, 阻燃等级 UL94 V-0
Case Material: Thermoplastic, flame retardant grade UL94 V-0
- 插套: 铜合金, 表面镀银
Contact bush: Copper alloy, silver plating

- 优越防护性能, 防护等级达到 IP44 (工作状态)
Excellent protection performance, protection grade IP44 (working condition)

电气性能 Electrical Performance

- 额定工作电流: 16A 或 32A
Rated current: 16A or 32A
- 工作电压: 240/415V
Operation voltage: 240/415V
- 绝缘电阻: > 1000MΩ (DC500V)
Insulation resistance: > 1000MΩ (DC500V)
- 端子温升: < 50K
Terminal temperature rise: < 50K
- 耐压: 2000V
Withstand Voltage: 2000V
- 接触阻抗: 0.5mΩ Max
Contact Resistance: 0.5mΩ Max

产品选型与标准配线 Model selection and the standard wiring

型号 / Model	额定电流 / Rated current	线缆规格 / Cable specification
RHTEC2e-EV16P	16A 单相 / Single phase	3 X 2.5mm ² + 1 X 0.75mm ²
	16A 三相 / Three phase	5 X 2.5mm ² + 1 X 0.75mm ²
RHTEC2e-EV32P	32A 单相 / Single phase	3 X 6mm ² + 1 X 0.75mm ²
	32A 三相 / Three phase	5 X 6mm ² + 1 X 0.75mm ²

IEC AC CHARGING SOCKET

IEC交流充电插座

产品应用: 充电桩端电连接输入
Product application: Charging pile electrical connection

型号 Model:

- V2-RHT EC2a-G-EV16S
- V2-RHT EC2a-G-EV32S

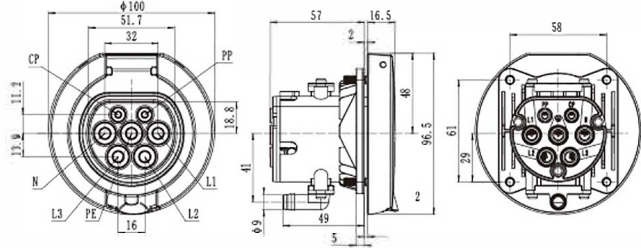

快速代码 Speed code: 2040

产品特点 Features

- 符合 62196-2 IEC 2010 SHEET 2-IIa 标准
Meet 62196-2 IEC 2010 SHEET 2-IIa standard
- 外形美观, 上翻盖防护, 支持前安装方式
Nice appearance, up flip protection, support front installation

机械性能 Mechanical properties

- 机械寿命: 空载拔插 >10000 次
Mechanical life: no-load plug in/pull out >10000 times
- 耦合时插拔力: >45N < 80N
Coupled insertion force: >45N < 80N

环境性能 Environmental performance

- 工作环境温度: -30°C ~ +50°C
Operating temperature: -30°C ~ +50°C

材料应用 Applied Materials

- 外壳材料: 热塑性塑料, 阻燃等级 UL94V-0
Case Material: Thermoplastic, flame retardant grade UL94V-0
- 插套: 铜合金, 表面镀银
Contact bush: Copper alloy, silver plating

- 可靠性材料, 阻燃、耐压、耐磨、耐冲击、高抗油
Reliability of materials, antifracking, pressure-resistant, abrasion resistance, impact resistance and high oil
- 优越防护性能, 防护等级达到 IP44 (工作状态)
Excellent protection performance, protection grade IP44 (working condition)

电气性能 Electrical Performance

- 额定工作电流: 16A 或 32A
Rated current: 16A or 32A
- 工作电压: 240/415V
Operation voltage: 240/415V
- 绝缘电阻: >1000MΩ (DC500V)
Insulation resistance: >1000MΩ (DC500V)
- 端子温升: <50K
Terminal temperature rise: <50K
- 耐压: 2000V
Withstand Voltage: 2000V
- 接触阻抗: 0.5mΩ Max
Contact Resistance: 0.5mΩ Max

产品选型与标准配线 Model selection and the standard wiring

型号 / Model	额定电流 / Rated current	线缆规格 / Cable specification
V2-RHT EC2a-G-EV16S	16A 单相 / Single phase	3 X 2.5mm ² + 2 X 0.75mm ²
	16A 三相 / Three phase	5 X 2.5mm ² + 2 X 0.75mm ²
V2-RHT EC2a-G-EV32S	32A 单相 / Single phase	3 X 6mm ² + 2 X 0.75mm ²
	32A 三相 / Three phase	5 X 6mm ² + 2 X 0.75mm ²

AC CHARGING PLUG 交流充电插头

产品应用: 电动汽车端电连接输入
Product application: Electric vehicle electrical connection

型号 Model:

- V3-RHTEC2e-EV32P
- V3-RHTEC2e-EV63P

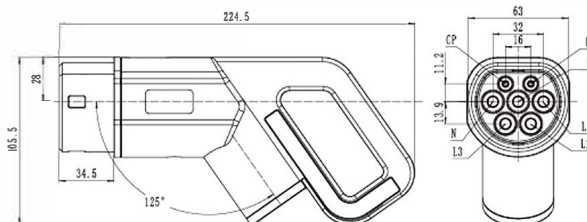

快速代码 Speed code: 2060

产品特点 Features

- 符合 62196-2 IEC 2010 SHEET 2-IIe 标准
Meet 62196-2 IEC 2010 SHEET 2-IIe standard
- 外形美观, 手持式设计符合人体工程学原理, 插拔便捷
Nice appearance, hand-held ergonomic design, easy plug

机械性能 Mechanical properties

- 机械寿命: 空载插拔 > 10000 次
Mechanical life: no-load plug in/pull out > 10000 times
- 耦合时插拔力: > 45N < 80N
Coupled insertion force: > 45N < 80N
- 抗冲击力: 可承受 1 米高度跌落与 2 吨车辆碾压压力
Impact of external force: can afford 1m drop and 2t vehicle run over pressure

环境性能 Environmental performance

- 工作环境温度: -30°C ~ +50°C
Operating temperature: -30°C ~ +50°C

材料应用 Applied Materials

- 外壳材料: 热塑性塑料, 阻燃等级 UL94 V-0
Case Material: Thermoplastic, flame retardant grade UL94 V-0
- 插套: 铜合金, 表面镀银
Contact bush: Copper alloy, silver plating

- 优越防护性能, 防护等级达到 IP55 (工作状态)
Excellent protection performance, protection grade IP55 (working condition)

电气性能 Electrical Performance

- 额定工作电流: 32A 或 63A
Rated current: 32A or 63A
- 工作电压: 240/415V
Operation voltage: 240/415V
- 绝缘电阻: > 1000MΩ (DC500V)
Insulation resistance: > 1000MΩ (DC500V)
- 端子温升: < 50K
Terminal temperature rise: < 50K
- 耐压: 2000V
Withstand Voltage: 2000V
- 接触阻抗: 0.5mΩ Max
Contact Resistance: 0.5mΩ Max

产品选型与标准配线 Model selection and the standard wiring

型号 / Model	额定电流 / Rated current	线缆规格 / Cable specification
V3-RHTEC2e-EV32P	32A 三相 / Three phase	5X 6mm ² + 2 X 0.5mm ²
V3-RHTEC2e-EV63P	63A 三相 / Three phase	5X 16mm ² + 5 X 0.75mm ²

AC CHARGING SOCKET

交流充电插座

产品应用: 电动汽车端电连接输入
Product application: Electric vehicle electrical connection

型号 Model:

● RHTEC2f-G-EV16S

● RHTEC2f-G-EV32S

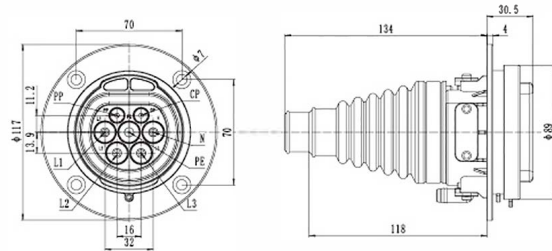

快速代码 Speed code: 2070

产品特点 Features

- 符合 62196-2 IEC 2010 SHEET 2-If 标准
Meet 62196-2 IEC 2010 SHEET 2-If standard
- 外形美观,带防护盖,支持前安装方式
Nice appearance, with protection cover, support front installation

机械性能 Mechanical properties

- 机械寿命: 空载拔插 >10000 次
Mechanical life :no-load plugin/pull out >10000 times
- 耦合时插拔力: >45N<80N
Coupled insertion force: >45N<80N

环境性能 Environmental performance

- 工作环境温度: -30°C ~+50°C
Operating temperature: -30°C~+50°C

材料应用 Applied Materials

- 外壳材料: 热塑性塑料,阻燃等级 UL94V-0
Case Material: Thermoplastic, flame retardant grade UL94 V-0
- 插针: 铜合金,表面镀银 + 顶部热塑性塑料
Pin: Copper alloy, silver + thermoplastic on the top

- 插针头部采用安全绝缘设计,防止人手意外直接接触
Safety pins insulated head design to prevent accidental direct contact with staff
- 优越防护性能,防护等级达到 IP44(工作状态)
Excellent protection performance, protection grade IP44(working condition)

电气性能 Electrical Performance

- 额定工作电流: 16A 或 32A
Rated current: 16A or 32A
- 工作电压: 250/415V
Operation voltage: 250/415V
- 绝缘电阻: >1000MΩ (DC500V)
Insulation resistance: >1000MΩ (DC500V)
- 端子温升: <50K
Terminal temperature rise: <50K
- 耐压: 2000V
Withstand Voltage: 2000V
- 接触阻抗: 0.5mΩ Max
Contact Resistance: 0.5mΩ Max

产品选型与标准配线 Model selection and the standard wiring

型号 /Model	额定电流 /Rated current	线缆规格 /Cable specification
RHTEC2f-G-EV16S	16A 单相 /Single phase	3 X 2.5mm ² + 2 X 0.75mm ²
	16A 三相 /Three phase	5 X 2.5mm ² + 2 X 0.75mm ²
RHTEC2f-G-EV32S	32A 单相 /Single phase	3 X 6mm ² + 2 X 0.75mm ²
	32A 三相 /Three phase	5 X 6mm ² + 2 X 0.75mm ²

AC CHARGING PLUG 交流充电插头

产品应用: 充电桩端电连接输入
Product application: Charging pile electrical connection

型号 Model:

- V4-RHTEC2b-EV16P
- V4-RHTEC2b-EV32P

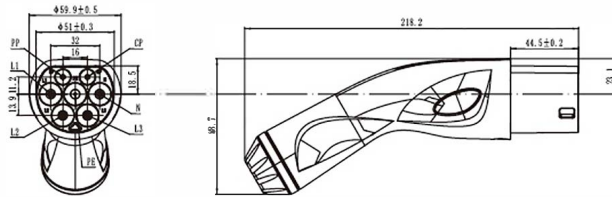

快速代码 Speed code: 2090

产品特点 Features

- 符合 62196-2 IEC 2010 SHEET 2-IIb 标准
Meet 62196-2 IEC 2010 SHEET 2-IIb standard
- 外形美观, 手持式设计符合人体工程学原理, 插拔便捷
Nice appearance, hand-held ergonomic design, easy plug

机械性能 Mechanical properties

- 机械寿命: 空载拔插 > 10000 次
Mechanical life: no-load plug in/pull out > 10000 times
- 抗冲击力: 可承受 1 米高度跌落与 2 吨车辆碾压力
Impact of external force: can afford 1m drop and 2t vehicle run over pressure

环境性能 Environmental performance

- 工作环境温度: -30°C ~ +50°C
Operating temperature: -30°C ~ +50°C

材料应用 Applied Materials

- 外壳材料: 热塑性塑料, 阻燃等级 UL94V-0
Case Material: Thermoplastic, flame retardant grade UL94 V-0
- 插针: 铜合金, 表面镀银 + 顶部热塑性塑料
Pin: Copper alloy, silver + thermoplastic on the top

- 插针头部采用安全绝缘设计, 防止人手意外直接接触
Safety pins insulated head design to prevent accidental direct contact with staff
- 优越防护性能, 防护等级达到 IP54 (工作状态)
Excellent protection performance, protection grade IP54 (working condition)

电气性能 Electrical Performance

- 额定工作电流: 16A 或 32A
Rated current: 16A or 32A
- 工作电压: 240/415V
Operation voltage: 240V or 415V
- 绝缘电阻: > 1000MΩ (DC500V)
Insulation resistance: > 1000MΩ (DC500V)
- 端子温升: < 50K
Terminal temperature rise: < 50K
- 耐压: 2000V
Withstand Voltage: 2000V
- 接触阻抗: 0.5mΩ Max
Contact Resistance: 0.5mΩ Max

产品选型与标准配线 Model selection and the standard wiring

型号 / Model	额定电流 / Rated current	线缆规格 / Cable specification
V4-RHTEC2b-EV16P	16A 单相 / Single phase	3 X 2.5mm ² + 1 X 0.75mm ²
	16A 三相 / Three phase	5 X 2.5mm ² + 1 X 0.75mm ²
V4-RHTEC2b-EV32P	32A 单相 / Single phase	3 X 6mm ² + 1 X 0.75mm ²
	32A 三相 / Three phase	5 X 6mm ² + 1 X 0.75mm ²

AC CHARGING PLUG 交流充电插头

产品应用: 电动汽车端电连接输入
Product application: Electric vehicle electrical connection

型号 Model:

● V4-RHTEC2e-EV16P

● V4-RHTEC2e-EV32P

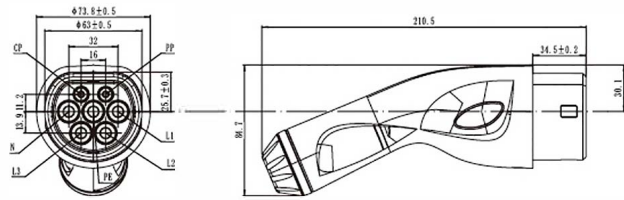

快速代码 Speed code: 2080

产品特点 Features

- 符合 62196-2 IEC 2010 SHEET 2-IIe 标准
Meet 62196-2 IEC 2010 SHEET 2-IIe standard
- 外形美观, 手持式设计符合人体工程学原理, 插拔便捷
Nice appearance, hand-held ergonomic design, easy plug

- 优越防护性能, 防护等级达到 IP54 (工作状态)
Excellent protection performance, protection grade IP54 (working condition)

机械性能 Mechanical properties

- 机械寿命: 空载插拔 > 10000 次
Mechanical life: no-load plug in/pull out > 10000 times
- 耦合时插拔力: > 45N < 80N
Coupled insertion force: > 45N < 80N
- 抗冲击力: 可承受 1 米高度跌落与 2 吨车辆碾压压力
Impact of external force: can afford 1m drop and 2t vehicle run over pressure

电气性能 Electrical Performance

- 额定工作电流: 16A 或 32A
Rated current: 16A or 32A
- 工作电压: 240/415V
Operation voltage: 240/415V
- 绝缘电阻: > 1000MΩ (DC500V)
Insulation resistance: > 1000MΩ (DC500V)
- 端子温升: < 50K
Terminal temperature rise: < 50K
- 耐压: 2000V
Withstand Voltage: 2000V
- 接触阻抗: 0.5mΩ Max
Contact Resistance: 0.5mΩ Max

环境性能 Environmental performance

- 工作环境温度: -30°C ~ +50°C
Operating temperature: -30°C ~ +50°C

材料应用 Applied Materials

- 外壳材料: 热塑性塑料, 阻燃等级 UL94 V-0
Case Material: Thermoplastic, flame retardant grade UL94 V-0
- 插套: 铜合金, 表面镀银
Contact bush: Copper alloy, silver plating

产品选型与标准配线 Model selection and the standard wiring

型号 / Model	额定电流 / Rated current	线缆规格 / Cable specification
V4-RHTEC2e-EV16P	16A 单相 / Single phase	3 X 2.5mm ² + 1 X 0.75mm ²
	16A 三相 / Three phase	5 X 2.5mm ² + 1 X 0.75mm ²
V4-RHTEC2e-EV32P	32A 单相 / Single phase	3 X 6mm ² + 1 X 0.75mm ²
	32A 三相 / Three phase	5 X 6mm ² + 1 X 0.75mm ²

COMBO 2

产品应用: 电动汽车端电连接输入
Product application: Electric vehicle electrical connection

型号 Model:

- RHTEC3m-EV80P
- RHTEC3m-EV150P
- RHTEC3m-EV200P

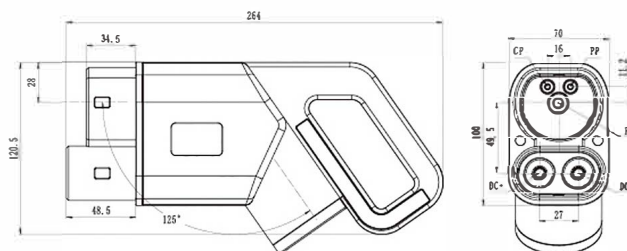

快速代码 Speed code: 2510

产品特点 Features

- 充电插头符合 62196-3 IEC 2011 SHEET 3-Im 标准
Charging plug meet 62196-3 IEC 2011 SHEET 3-Im standard
- 外壳整体结构提升防护性能
Housing massive structure promote protection performance

机械性能 Mechanical properties

- 机械寿命: 空载拔插 > 10000 次
Mechanical life : no-load plug in/pull out > 10000 times
- 抗冲击力: 可承受 1 米高度跌落与 2 吨车辆碾压力
Impact of external force: can afford 1m drop and 2t vehicle run over pressure

环境性能 Environmental performance

- 工作环境温度: -30°C ~+50°C
Operating temperature: -30°C~+50°C

材料应用 Applied Materials

- 外壳材料: 热塑性塑料, 阻燃等级 UL94 V-0
Case Material: Thermoplastic, flame retardant grade UL94 V-0
- 插套: 铜合金, 表面镀银
Contact bush: Copper alloy, silver plating

- 产品整体插拔力 < 100N
Product entire insertion and extraction force < 100N
- 防护等级 IP55
Protection class IP55
- 最大充电功率: 127.5kW
Max charging power: 127.5kW

电气性能 Electrical Performance

- 工作电流: 150A
Rated current: 150A
- 工作电压: 1000V DC
Operation voltage: 1000V DC
- 绝缘电阻: >2000MΩ (DC1000V)
Insulation resistance: >2000MΩ (DC1000V)
- 端子温升: <50K
Terminal temperature rise: <50K
- 耐压: 3200V
Withstand Voltage: 3200V
- 接触阻抗: 0.5mΩ Max
Contact Resistance: 0.5mΩ Max

产品选型与标准配线 Model selection and the standard wiring

型号 /Model	额定电流 /Rated current	线缆规格 /Cable specification
RHTEC3m-EV80P	80A	3 X 16mm ² + 6 X 0.75mm ²
RHTEC3m-EV150P	150A	2 X 50mm ² + 1 X 25mm ² + 6 X 0.75mm ²
RHTEC3m-EV200P	200A	2 X 70mm ² + 1 X 25mm ² + 6 X 0.75mm ²

COMBO 2

产品应用: 电动汽车端电连接输入
Product application: Electric vehicle electrical connection

型号Model:

- RHTEC3m-EV80S
- RHTEC3m-EV150S
- RHTEC3m-EV200S

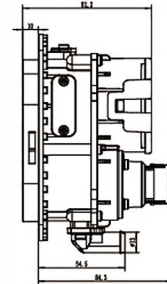
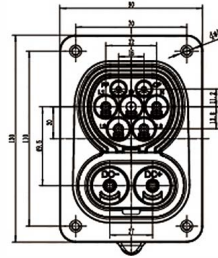

快速代码 Speed code: 2520

产品特点 Features

- 充电插座符合 62196-3 IEC 2011 SHEET 3-Im 标准
Charging plug meet 62196-3 IEC 2011 SHEET 3-Im standard
- 外形简洁, 支持后安装方式
Concise appearance, support back installation
- 触头设计排水结构, 提升安全性能
Contact with drainage structure, improve safety performance
- 插针头部采用安全绝缘设计, 防止人手意外直接接触
Safety pins insulated head design to prevent accidental direct contact with staff

机械性能 Mechanical properties

- 机械寿命: 空载拔插 > 10000 次
Mechanical life: no-load plug in/pull out > 10000 times

环境性能 Environmental performance

- 工作环境温度: -30°C ~ +50°C
Operating temperature: -30°C ~ +50°C

材料应用 Applied Materials

- 外壳材料: 热塑性塑料, 阻燃等级 UL94 V-0
Case Material: Thermoplastic, flame retardant grade UL94 V-0
- 插针: 铜合金, 表面镀银 + 顶部热塑性塑料
Pin: Copper alloy, silver + thermoplastic on the top

- 背面防护等级 IP55 (工作状态)
Back protection class IP55 (Working state)
- 直流最大充电功率: 127.5kW
DC max charging power: 127.5 kW
- 交流最大充电功率: 41.5kW
AC max charging power: 41.5kW

电气性能 Electrical Performance

- 直流输入: 80A/150A/200A 1000V DC
DC input: 80A/150A/200A 1000V DC
- 交流输入: 16A 32A 63A 240/415V AC
AC input: 16A 32A 63A 240/415V AC
- 绝缘电阻: > 2000MΩ (DC1000V)
Insulation resistance: > 2000MΩ (DC1000V)
- 端子温升: < 50K
Terminal temperature rise: < 50K
- 耐压: 3200V
Withstand Voltage: 3200V
- 接触阻抗: 0.5mΩ Max
Contact Resistance: 0.5mΩ Max

产品选型与标准配线 Model selection and the standard wiring

型号 / Model	额定电流 / Rated current	线缆规格 / Cable specification
RHTEC3m-EV80S	直流 80A / 交流 32A	2 X 16mm ² + 1 X 25mm ² + 4 X 6mm ² + 6 X 0.75mm ²
RHTEC3m-EV150S	直流 150A / 交流 63A	2 X 50mm ² + 1 X 25mm ² + 4 X 16mm ² + 6 X 0.75mm ²
RHTEC3m-EV200S	直流 200A / 交流 63A	2 X 70mm ² + 1 X 25mm ² + 4 X 16mm ² + 6 X 0.75mm ²

COMBO 1

产品应用: 电动汽车端电连接输入
Product application: Electric vehicle electrical connection

型号 Model:

● RHTEC3J-EV150P

● RHTEC3J-EV200P

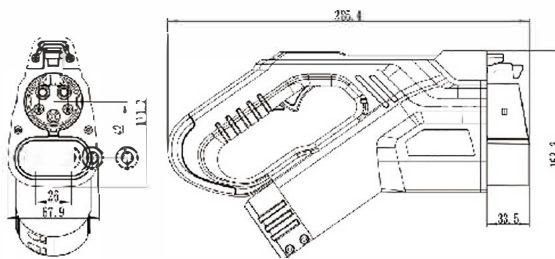

产品特点 Features

- 充电插头符合 62196-3 IEC 2014 SHEET 3-IIIB 标准
Charging plug meet 62196-3 IEC 2014 SHEET 3-IIIB standard
- 外壳整体结构提升防护性能
Housing massive structure promote protection performance
- 产品整体插拔力 < 100N
Product entire insertion and extraction force < 100N
- 防护等级 IP65
Protection class IP65
- 最大充电功率: 90kW
Max charging power: 90kW

机械性能 Mechanical properties

- 机械寿命: 空载拔插 > 10000 次
Mechanical life: no-load plug in/pull out > 10000 times
- 抗冲击力: 可承受 1 米高度跌落与 2 吨车辆碾压力
Impact of external force: can afford 1m drop and 2t vehicle run over pressure

环境性能 Environmental performance

- 工作环境温度: -30°C ~ +50°C
Operating temperature: -30°C ~ +50°C

材料应用 Applied Materials

- 外壳材料: 热塑性塑料, 阻燃等级 UL94 V-0
Case Material: Thermoplastic, flame retardant grade UL94 V-0
- 插套: 铜合金, 表面镀银
Contact bush: Copper alloy, silver plating

电气性能 Electrical Performance

- 工作电流: 150A
Rated current: 150A
- 工作电压: 600V DC
Operation voltage: 600V DC
- 绝缘电阻: > 2000MΩ (DC1000V)
Insulation resistance: > 2000MΩ (DC1000V)
- 端子温升: < 50K
Terminal temperature rise: < 50K
- 耐压: 3200V
Withstand Voltage: 3200V
- 接触阻抗: 0.5mΩ Max
Contact Resistance: 0.5mΩ Max

产品选型与标准配线 Model selection and the standard wiring

型号 / Model	额定电流 / Rated current	线缆规格 / Cable specification
RHTEC3J-EV150P	150A	2 X 50mm ² + 1 X 6mm ² + 6 X 0.75mm ²
RHTEC3J-EV200P	200A	2 X 70mm ² + 1 X 6mm ² + 6 X 0.75mm ²

COMBO 1

产品应用: 电动汽车端电连接输入
Product application: Electric vehicle electrical connection

型号 Model:
● RHTEC3j-G-EVXXSXX

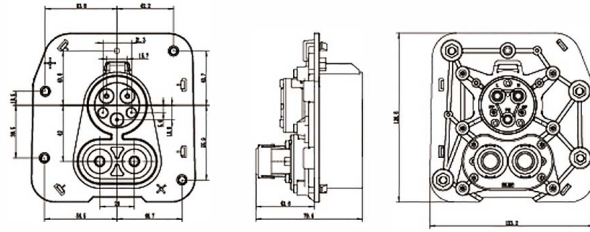

产品特点 Features

- 充电插座符合 SAE J1772-2016 标准
Charging socket conforms to SAE J1772-2016 standard
- 外形简洁, 支持后安装方式
Concise appearance, support back installation
- 插针头部采用安全绝缘设计, 防止人手意外直接接触
Safety pins insulated head design to prevent accidental direct contact with staff

机械性能 Mechanical properties

- 机械寿命: 空载拔插 > 10000 次
Mechanical life: no-load plug in/pull out > 10000 times

环境性能 Environmental performance

- 工作环境温度: -30°C ~ +50°C
Operating temperature: -30°C ~ +50°C

材料应用 Applied Materials

- 外壳材料: 热塑性塑料, 阻燃等级 UL94 V-0
Case Material: Thermoplastic, flame retardant grade UL94 V-0
- 插针: 铜合金, 表面镀银 + 顶部热塑性塑料
Pin: Copper alloy, silver + thermoplastic on the top

- 产品整体防护等级 3S
Overall product protection level 3S
- 背面防护等级 IP65
Back protection class IP65

电气性能 Electrical Performance

- 直流输入: 80A/150A/200A 600V DC
DC input: 80A/150A/200A 600V DC
- 工交流输入: 16A/32A/60A 240/415V AC
AC input: 16A/32A/60A 240/415V AC
- 绝缘电阻: >2000MΩ(DC500V)
Insulation resistance: >2000MΩ(DC500V)
- 端子温升: <50K
Terminal temperature rise: <50K
- 耐压: 3000V
Withstand Voltage: 3000V
- 接触阻抗: 0.5mΩ Max
Contact Resistance: 0.5mΩ Max

产品选型与标准配线 Model selection and the standard wiring

型号 /Model	额定电流 /DC/AC	线缆规格 /Cable specification
RHTEC3j-G-EV80S16	80A/16A	2×5AWG+1×8AWG+2×14AWG+2×20AWG
RHTEC3j-G-EV80S32	80A/32A	2×5AWG+1×8AWG+2×10AWG+2×20AWG
RHTEC3j-G-EV150S16	150A/16A	2×1AWG+1×6AWG+2×14AWG+2×20AWG
RHTEC3j-G-EV150S32	150A/32A	2×1AWG+1×6AWG+2×10AWG+2×20AWG
RHTEC3j-G-EV150S60	150A/60A	2×1AWG+1×6AWG+2×6AWG+2×20AWG
RHTEC3j-G-EV200S16	200A/16A	2×2,0AWG+1×6AWG+2×14AWG+2×20AWG
RHTEC3j-G-EV200S32	200A/32A	2×2,0AWG+1×6AWG+2×10AWG+2×20AWG
RHTEC3j-G-EV200S60	200A/60A	2×2,0AWG+1×6AWG+2×6AWG+2×20AWG

AC CHARGING PLUG 交流充电插头

产品应用: 电动汽车端电连接输入
Product application: Electric vehicle electrical connection

型号 Model:

- V3-RHT-EV16P
- V3-RHT-EV32P
- V3-RHT-EV40P
- V3-RHT-EV50P

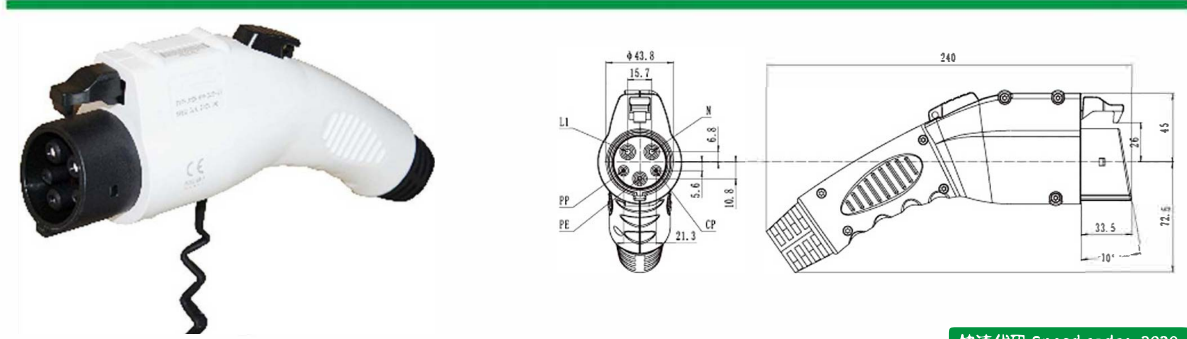

快速代码 Speed code: 3030

产品特点 Features

- 符合 SAE J1772-2010 标准
Meet SAE J1772-2010 standard
- 外形美观,手持式设计符合人体工程学原理,插拔便捷
Nice appearance, hand-held ergonomic design, easy plug
- 优越防护性能,防护等级达到 IP44(工作状态)
Excellent protection performance, protection grade IP44 (工作状态)

机械性能 Mechanical properties

- 机械寿命: 空载插拔 > 10000 次
Mechanical life: no-load plug in/pull out > 10000 times
- 耦合时插拔力: > 45N < 80N
Coupled insertion force: > 45N < 80N

环境性能 Environmental performance

- 工作环境温度: -30°C ~ +50°C
Operating temperature: -30°C ~ +50°C

材料应用 Applied Materials

- 外壳材料: 热塑性塑料,阻燃等级 UL94 V-0
Case Material: Thermoplastic, flame retardant grade UL94 V-0
- 插套: 铜合金,表面镀银
Contact bush: Copper alloy, silver plating

电气性能 Electrical Performance

- 额定工作电流: 16A 或 32A 或 40A 或 50A
Rated current: 16A or 32A or 40A or 50A
- 工作电压: 240V
Operation voltage: 240V
- 绝缘电阻: > 1000MΩ (DC500V)
Insulation resistance: > 1000MΩ (DC500V)
- 端子温升: < 50K
Terminal temperature rise: < 50K
- 耐压: 2000V
Withstand Voltage: 2000V
- 接触阻抗: 0.5mΩ Max
Contact Resistance: 0.5mΩ Max

产品选型与标准配线 Model selection and the standard wiring

型号 / Model	额定电流 / Rated current	线缆规格 / Cable specification
V3-RHT-EV16P	16A	3 X 2.5mm ² + 2 X 0.5mm ² / 3 X 14AWG + 1 X 18AWG
V3-RHT-EV32P	32A	3 X 6mm ² + 2 X 0.5mm ² / 3 X 10AWG + 1 X 18AWG
V3-RHT-EV40P	40A	2 X 8AWG + 1 X 10AWG + 1 X 16AWG
V3-RHT-EV50P	50A	2 X 8AWG + 1 X 10AWG + 1 X 16AWG

AC CHARGING SOCKET

交流充电插座

产品应用: 电动汽车端电连接输入
Product application: Electric vehicle electrical connection

型号 Model:

- V3-RHT-G-EV16S
- V3-RHT-G-EV32S
- V3-RHT-G-EV40S
- V3-RHT-G-EV50S

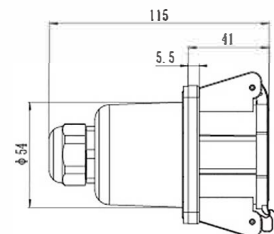
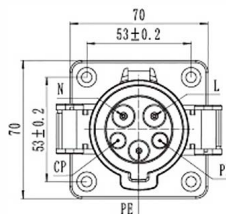
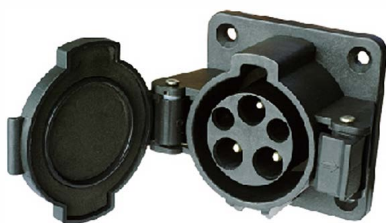

快速代码 Speed code: 3040

产品特点 Features

- 符合 SAE J1772-2010 标准
Meet SAE J1772-2010 standard
- 外形美观, 左开盖防护, 支持前安装方式
Nice appearance, left flip protection, support front installation

- 可靠性材料, 阻燃、耐压、耐磨、耐冲击、高抗油
Reliability of materials, antifracking, pressure-resistant, abrasion resistance, impact resistance and high oil
- 优越防护性能, 防护等级达到 IP44 (工作状态)
Excellent protection performance, protection grade IP44 (working condition)

机械性能 Mechanical properties

- 机械寿命: 空载拔插 > 10000 次
Mechanical life: no-load plug in/pull out > 10000 times

电气性能 Electrical Performance

- 额定工作电流: 16A 或 32A 或 40A 或 50A
Rated current: 16A or 32A or 40A or 50A
- 工作电压: 240V
Operation voltage: 240V
- 绝缘电阻: > 1000MΩ (DC500V)
Insulation resistance: > 1000MΩ (DC500V)
- 端子温升: < 50K
Terminal temperature rise: < 50K
- 耐压: 2000V
Withstand Voltage: 2000V
- 接触阻抗: 0.5mΩ Max
Contact Resistance: 0.5mΩ Max

环境性能 Environmental performance

- 工作环境温度: -30°C ~ +50°C
Operating temperature: -30°C ~ +50°C

材料应用 Applied Materials

- 外壳材料: 热塑性塑料, 阻燃等级 UL94 V-0
Case Material: Thermoplastic, flame retardant grade UL94 V-0
- 插针: 铜合金, 表面镀银
Pin: Copper alloy, silver plating

产品选型与标准配线 Model selection and the standard wiring

型号 / Model	额定电流 / Rated current	线缆规格 / Cable specification
V3-RHT-G-EV16S	16A	3 X 2.5mm ² + 2 X 0.75mm ²
V3-RHT-G-EV32S	32A	3 X 6mm ² + 2 X 0.75mm ²
V3-RHT-G-EV40S	40A	2 X 8AWG + 1 X 10AWG + 1 X 16AWG
V3-RHT-G-EV50S	50A	2 X 8AWG + 1 X 10AWG + 1 X 16AWG

AC CHARGING PLUG 交流充电插头

产品应用: 电动汽车端电连接输入
Product application: Electric vehicle electrical connection

型号 Model:

● V5-RH1-EV16P

● V5-RH1-EV32P

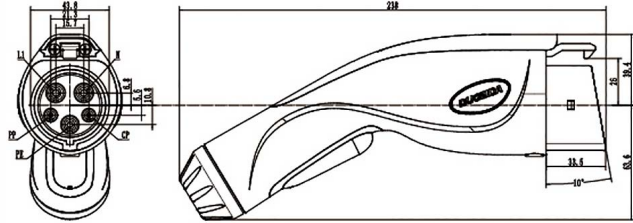
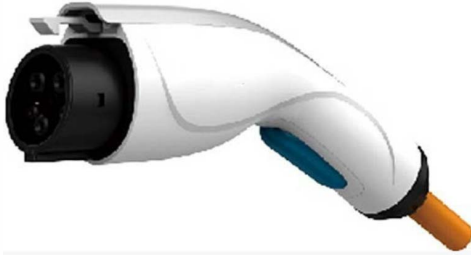

快速代码 Speed code: 3050

产品特点 Features

- 符合 SAE J1772-2010 标准
Meet SAE J1772-2010 standard
- 外形美观, 手持式设计符合人体工程学原理, 插拔便捷
Nice appearance, hand-held ergonomic design, easy plug

- 优越防护性能, 防护等级达到 4X(工作状态)
Excellent protection performance, protection grade 4X(working condition)

机械性能 Mechanical properties

- 机械寿命: 空载拔插 >10000 次
Mechanical life: no-load plug in/pull out >10000 times
- 耦合时插拔力: >45N <80N
Coupled insertion force: >45N <80N

电气性能 Electrical Performance

- 额定工作电流: 16A 或 32A
Rated current: 16A or 32A
- 工作电压: 240V
Operation voltage: 240V
- 绝缘电阻: >1000MΩ (DC500V)
Insulation resistance: >1000MΩ (DC500V)
- 端子温升: <50K
Terminal temperature rise: <50K
- 耐压: 2000V
Withstand Voltage: 2000V
- 接触阻抗: 0.5mΩ Max
Contact Resistance: 0.5mΩ Max

环境性能 Environmental performance

- 工作环境温度: -30°C ~ +50°C
Operating temperature: -30°C ~ +50°C

材料应用 Applied Materials

- 外壳材料: 热塑性塑料, 阻燃等级 UL94 V-0
Case Material: Thermoplastic, flame retardant grade UL94 V-0
- 插套: 铜合金, 表面镀银
Contact bush: Copper alloy, silver plating

产品选型与标准配线 Model selection and the standard wiring

型号 / Model	额定电流 / Rated current	线缆规格 / Cable specification
V5-RH1-EV16P	16A	3 X 2.5mm ² + 2 X 0.5mm ² / 3 X 14AWG + 1 X 18AWG
V5-RH1-EV32P	32A	3 X 6mm ² + 2 X 0.5mm ² / 3 X 10AWG + 1 X 18AWG

EV Conductive Charging Connection Device Selection Guide. EV传导充电连接装置选型引导

企业标准EV交流充电连接装置 Enterprise standard EV AC charging connection device

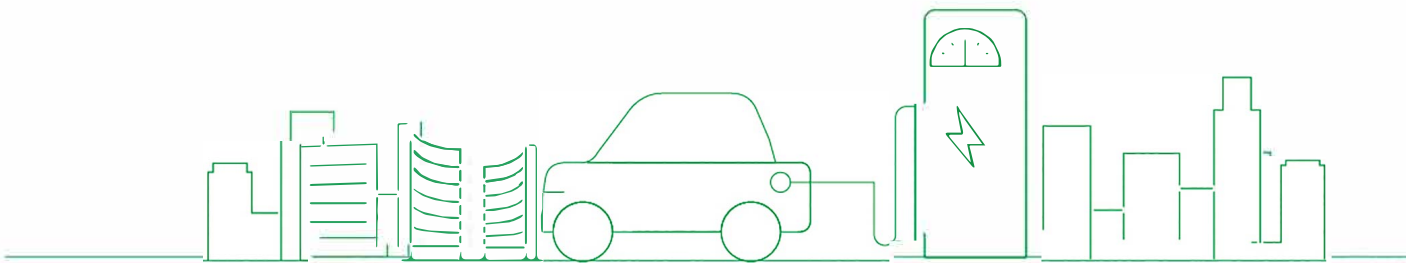
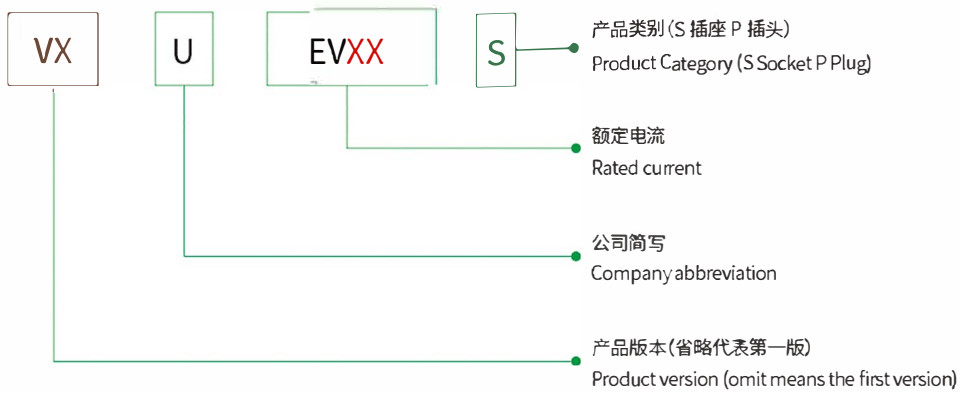

AC CHARGING PLUG 交流充电插头

产品应用: 电动汽车端电连接输入
Product application: Electric vehicle electrical connection

型号 Model:
● V3-U-EV16P

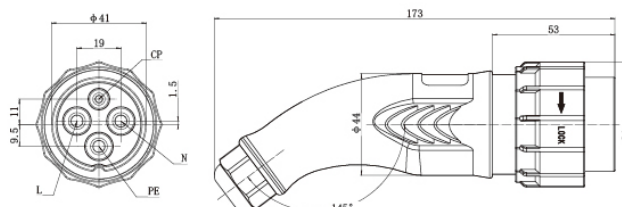

快速代码 Speed code: 5020

产品特点 Features

- 符合 GB/T 20234-2006 规定及要求
Comply GB/T 20234-2006 regulations and requirements
- 外形美观, 手持式设计符合人体工程学原理, 插拔便捷
Nice appearance, hand-held ergonomic design, easy plug
- 优越防护性能, 防护等级达到 IP44(工作状态)
Excellent protection performance, protection grade IP44(working condition)

机械性能 Mechanical properties

- 机械寿命: 空载拔插 >10000 次
Mechanical life: no-load plug in/pull out >10000 times
- 耦合时插拔力: $\leq 80\text{N}$
Coupled insertion force: $\leq 80\text{N}$

环境性能 Environmental performance

- 工作环境温度: $-30^{\circ}\text{C} \sim +50^{\circ}\text{C}$
Operating temperature: $-30^{\circ}\text{C} \sim +50^{\circ}\text{C}$

材料应用 Applied Materials

- 外壳材料: 热塑性塑料, 阻燃等级 UL94 V-0
Case Material: Thermoplastic, flame retardant grade UL94 V-0
- 插套: 铜合金, 表面镀银
Contact bush: Copper alloy, silver plating

电气性能 Electrical Performance

- 额定工作电流: 16A
Rated current: 16A
- 工作电压: 250V
Operation voltage: 250V
- 绝缘电阻: $>500\text{M}\Omega$ (DC500V)
Insulation resistance: $>500\text{M}\Omega$ (DC500V)
- 端子温升: $<50\text{K}$
Terminal temperature rise: $<50\text{K}$
- 耐压: 2000V
Withstand Voltage: 2000V
- 接触阻抗: $0.5\text{m}\Omega$ Max
Contact Resistance: $0.5\text{m}\Omega$ Max

产品选型与标准配线 Model selection and the standard wiring

型号 /Model	额定电流 /Rated current	线缆规格 /Cable specification
V3-U-EV16P	16A	3X 2.5mm ²

AC CHARGING SOCKET

交流充电插座

产品应用: 电动汽车端电连接输入
Product application: Electric vehicle electrical connection

型号 Model:
● V3-U-EV16S

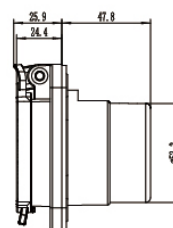
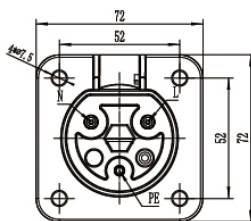

快速代码 Speed code: 5050

产品特点 Features

- 符合 GB/T 20234-2006 规定及要求
Comply GB/T 20234-2006 regulations and requirements
- 外形美观, 带防护盖, 支持前安装方式
Nice appearance, with protective cover, support front installation

- 可靠性材料, 阻燃、耐压、耐磨、耐冲击、高抗油
Reliability of materials, antiflaming, pressure-resistant, abrasion resistance, impact resistance and high oil
- 优越防护性能, 防护等级达到 IP44 (工作状态)
Excellent protection performance, protection grade IP44 (working condition)

机械性能 Mechanical properties

- 机械寿命: 空载拔插 > 10000 次
Mechanical life: no-load plug in/pull out > 10000 times

电气性能 Electrical Performance

- 额定工作电流: 16A
Rated current: 16A
- 工作电压: 250V
Operation voltage: 250V
- 绝缘电阻: > 500MΩ (DC500V)
Insulation resistance: > 500MΩ (DC500V)
- 端子温升: < 50K
Terminal temperature rise: < 50K
- 耐压: 2000V
Withstand Voltage: 2000V
- 接触阻抗: 0.5mΩ Max
Contact Resistance: 0.5mΩ Max

环境性能 Environmental performance

- 工作环境温度: -30°C ~ +50°C
Operating temperature: -30°C ~ +50°C

材料应用 Applied Materials

- 外壳材料: 热塑性塑料, 阻燃等级 UL94 V-0
Case Material: Thermoplastic, flame retardant grade UL94 V-0
- 插针: 铜合金, 表面镀银
Pin: Copper alloy, silver plating

产品选型与标准配线 Model selection and the standard wiring

型号 / Model	额定电流 / Rated current	线缆规格 / Cable specification
V3-U-EV16S	16A	3X 2.5mm ²

AC CHARGING PLUG 交流充电插头

产品应用: 电动汽车端电连接输入
Product application: Electric vehicle electrical connection

型号 Model:
● U-EV16P

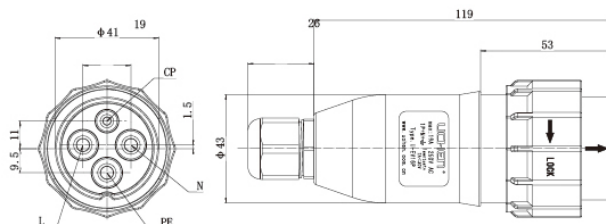

快速代码 Speed code: 5010

产品特点 Features

- 符合 GB/T 20234-2006 规定及要求
Comply GB/T 20234-2006 regulations and requirements
- 外形美观, 手持式设计符合人体工程学原理, 插拔便捷
Nice appearance, hand-held ergonomic design, easy plug
- 优越防护性能, 防护等级达到 IP44 (工作状态)
Excellent protection performance, protection grade IP44 (working condition)

机械性能 Mechanical properties

- 机械寿命: 空载拔插 > 10000 次
Mechanical life: no-load plug in/pull out > 10000 times
- 耦合时插拔力: $\leq 80\text{N}$
Coupled insertion force: $\leq 80\text{N}$

环境性能 Environmental performance

- 工作环境温度: $-30^{\circ}\text{C} \sim +50^{\circ}\text{C}$
Operating temperature: $-30^{\circ}\text{C} \sim +50^{\circ}\text{C}$

材料应用 Applied Materials

- 外壳材料: 热塑性塑料, 阻燃等级 UL94 V-0
Case Material: Thermoplastic, flame retardant grade UL94 V-0
- 插套: 铜合金, 表面镀银
Contact bush: Copper alloy, silver plating

电气性能 Electrical Performance

- 额定工作电流: 16A
Rated current: 16A
- 工作电压: 250V
Operation voltage: 250V
- 绝缘电阻: $> 500\text{M}\Omega$ (DC500V)
Insulation resistance: $> 500\text{M}\Omega$ (DC500V)
- 端子温升: $< 50\text{K}$
Terminal temperature rise: $< 50\text{K}$
- 耐压: 2000V
Withstand Voltage: 2000V
- 接触阻抗: $0.5\text{m}\Omega$ Max
Contact Resistance: $0.5\text{m}\Omega$ Max

产品选型与标准配线 Model selection and the standard wiring

型号 / Model	额定电流 / Rated current	线缆规格 / Cable specification
U-EV16P	16A	3X 2.5mm ²

AC CHARGING PLUG

交流充电插头

产品应用: 电动汽车端电连接输入
Product application: Electric vehicle electrical connection

型号 Model:
● V2-U-EV16P

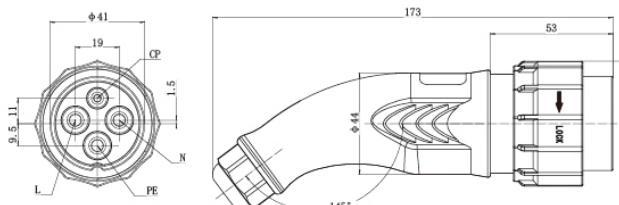

快速代码 Speed code: 5020

产品特点 Features

- 符合 GB/T 20234-2006 规定及要求
Comply GB/T 20234-2006 regulations and requirements
- 外形美观, 手持式设计符合人体工程学原理, 插拔便捷
Nice appearance, hand-held ergonomic design, easy plug
- 优越防护性能, 防护等级达到 IP44 (工作状态)
Excellent protection performance, protection grade IP44 (working condition)

机械性能 Mechanical properties

- 机械寿命: 空载插拔 > 10000 次
Mechanical life: no-load plug in/pull out > 10000 times
- 耦合时插拔力: ≤ 80N
Coupled insertion force: ≤ 80N

环境性能 Environmental performance

- 工作环境温度: -30°C ~ +50°C
Operating temperature: -30°C ~ +50°C

材料应用 Applied Materials

- 外壳材料: 热塑性塑料, 阻燃等级 UL94 V-0
Case Material: Thermoplastic, flame retardant grade UL94 V-0
- 插套: 铜合金, 表面镀银
Contact bush: Copper alloy, silver plating

电气性能 Electrical Performance

- 额定工作电流: 16A
Rated current: 16A
- 工作电压: 250V
Operation voltage: 250V
- 绝缘电阻: > 500MΩ (DC500V)
Insulation resistance: > 500MΩ (DC500V)
- 端子温升: < 50K
Terminal temperature rise: < 50K
- 耐压: 2000V
Withstand Voltage: 2000V
- 接触阻抗: 0.5mΩ Max
Contact Resistance: 0.5mΩ Max

产品选型与标准配线 Model selection and the standard wiring

型号 / Model	额定电流 / Rated current	线缆规格 / Cable specification
V2-U-EV16P	16A	3X 2.5mm ²

EV Conductive Charging Connection Assembly Option Guide EV传导充电用连接总成选型引导

充电模式2 CHARGING MODE 2

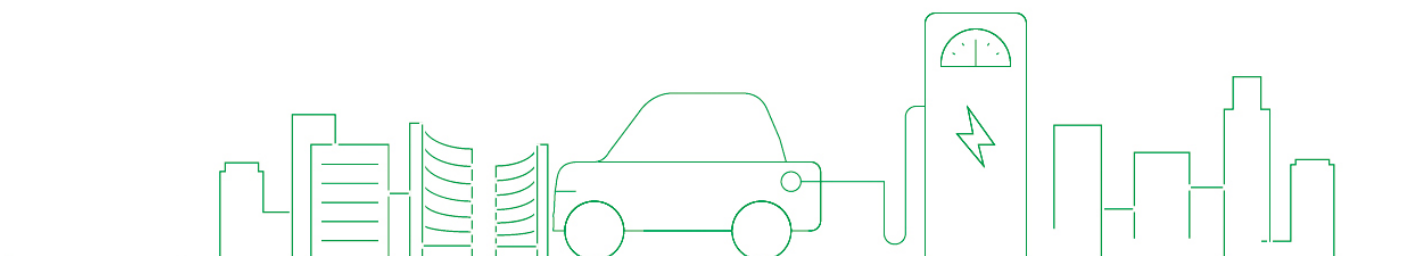
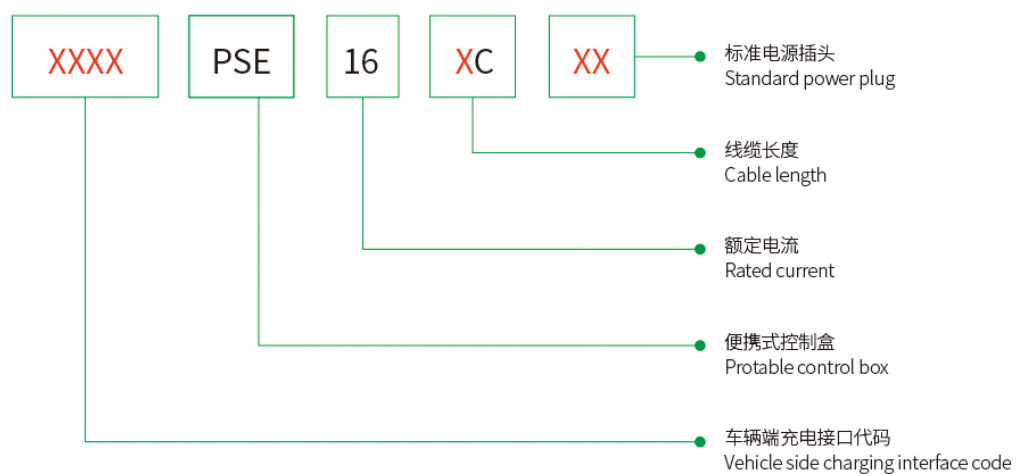

CHARGING MODE 2

充电模式2

产品应用:电动汽车端电连接输入
Product application:Electric vehicle electrical connection

型号 Model:

● 1100-PSE-16-XC-NS



接线方式 Wiring mode

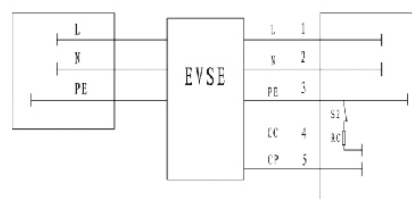

快速代码 Speed code: 1100

产品特点 Features

- 充电插头符合 GB/T 20234.2-2015 规定及要求
Charging plug meet GB/T 20234.2-2015 regulations and requirements
- 电源插头符合 GB 2099.1-2008 规定及要求,可选择搭载温度保护装置
Power plug meet GB 2099.1-2008 regulations and requirements,can choose with temperature protection device

机械性能 Mechanical properties

- 机械寿命: 空载拔插 > 10000 次
Mechanical life : no-load plug in/pull out > 10000 times
- 抗冲击力: 可承受 1 米高度跌落与 2 吨车辆碾压力
Impat of external force: can afford 1m drop and 2t vehicle run over pressure

环境性能 Environmental performance

- 工作环境温度: -30°C ~+50°C
Operating temperature: -30°C~+50°C

材料应用 Applied Materials

- 外壳材料: 热塑性塑料,阻燃等级 UL94 V-0
Case Material: Thermoplastic,flame retardant grade UL94 V-0
- 插针: 铜合金,表面镀银 + 顶部热塑性塑料
Pin: Copper alloy,silver + thermoplastic on the top

- 控制盒符合 GB/T 20234.2-2011 控制原理
Control box meet GB/T 20234.2-2011 control principle
- 优越防护性能,枪头防护等级达到 IP55(工作状态),控制盒防护等级达到 IP55/IP67(工作状态)
Excellent protection performance, plug IP55(working condition),PSE IP55/67(working condition)

电气性能 Electrical Performance

- 额定电流电压: 220V AC 16A
Rated current and voltage : 220V AC 16A
- 绝缘电阻: > 1000MΩ(DC500V)
Insulation resistance: >1000MΩ(DC500V)
- 端子温升: < 50K
Terminal temperature rise : <50K
- 耐压: 2000V
Withstand Voltage : 2000V

控制盒功能 Control Box Function

- 漏电保护(重启恢复)
Leakage protection(restart recover)
- 过压欠压保护(自检恢复)
Overvoltage under- voltage protection(self-checking recover)
- 过载保护(自检恢复)
Overload protection(self-checking recover)
- 防雷击保护
Lightning protection

产品选型与标准配线 Model selection and the standard wiring

型号 /Model	额定电流 /Rated current	线缆规格 /Cable specification
1100-PSE-16-XC-NS	16A	3 X 2.5mm ² + 2 X 0.75mm ²

CHARGING MODE 2

充电模式2

产品应用: 电动汽车端电连接输入
Product application: Electric vehicle electrical connection

型号 Model:

● 1160-PSE-16-XC-NS



接线方式 Wiring mode

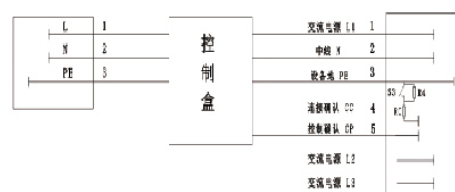

快速代码 Speed code: 1160

- 充电插头符合 GB/T 20234.2-2015 规定及要求
Charging plug meet GB/T 20234.2-2015 regulations and requirements
- 电源插头符合 GB 2099.1-2008 规定及要求, 可选择搭载温度保护装置
Power plug meet GB 2099.1-2008 regulations and requirements, can choose with temperature protection device

机械性能 Mechanical properties

- 机械寿命: 空载拔插 > 10000 次
Mechanical life: no-load plug in/pull out > 10000 times
- 抗冲击力: 可承受 1 米高度跌落与 2 吨车辆碾压力
Impact of external force: can afford 1m drop and 2t vehicle run over pressure

环境性能 Environmental performance

- 工作环境温度: -30°C ~ +50°C
Operating temperature: -30°C ~ +50°C

材料应用 Applied Materials

- 外壳材料: 热塑性塑料, 阻燃等级 UL94 V-0
Case Material: Thermoplastic, flame retardant grade UL94 V-0
- 插针: 铜合金, 表面镀银 + 顶部热塑性塑料
Pin: Copper alloy, silver + thermoplastic on the top

- 控制盒符合 GB/T 20234.2-2011 控制原理
Control box meet GB/T 20234.2-2011 control principle
- 优越防护性能, 枪头防护等级达到 IP55(工作状态), 控制盒防护等级达到 IP55/IP67(工作状态)
Excellent protection performance, plug IP55(working condition), PSE IP55/67(working condition)

电气性能 Electrical Performance

- 额定电流电压: 220V AC 16A
Rated current and voltage: 220V AC 16A
- 绝缘电阻: > 1000MΩ (DC500V)
Insulation resistance: > 1000MΩ (DC500V)
- 端子温升: < 50K
Terminal temperature rise: < 50K
- 耐压: 2000V
Withstand Voltage: 2000V

控制盒功能 Control Box Function

- 漏电保护 (重启恢复)
Leakage protection (restart recover)
- 过压欠压保护 (自检恢复)
Overvoltage under-voltage protection (self-checking recover)
- 过载保护 (自检恢复)
Overload protection (self-checking recover)
- 防雷击保护
Lightning protection

产品选型与标准配线 Model selection and the standard wiring

型号 / Model	额定电流 / Rated current	线缆规格 / Cable specification
1160-PSE-16-XC-NS	16A	3 X 2.5mm ² + 2 X 0.75mm ²

CHARGING MODE 2

充电模式2

产品应用: 电动汽车端电连接输入
Product application: Electric vehicle electrical connection

型号 Model:

1180-PSE-16-XC-NS



接线方式 Wiring mode

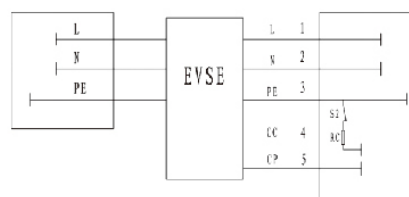

快速代码 Speed code: 1180

产品特点 Features

- 充电插头符合 GB/T 20234.2-2015 规定及要求
Charging plug meet GB/T 20234.2-2015 regulations and requirements
- 电源插头符合 GB 2099.1-2008 规定及要求, 可选择搭载温度保护装置
Power plug meet GB 2099.1-2008 regulations and requirements, can choose with temperature protection device

机械性能 Mechanical properties

- 机械寿命: 空载拔插 > 10000 次
Mechanical life: no-load plug in/pull out > 10000 times
- 抗冲击力: 可承受 1 米高度跌落与 2 吨车辆碾压力
Impact of external force: can afford 1m drop and 2t vehicle run over pressure

环境性能 Environmental performance

- 工作环境温度: -30°C ~ +50°C
Operating temperature: -30°C ~ +50°C

材料应用 Applied Materials

- 外壳材料: 热塑性塑料, 阻燃等级 UL94 V-0
Case Material: Thermoplastic, flame retardant grade UL94 V-0
- 插针: 铜合金, 表面镀银 + 顶部热塑性塑料
Pin: Copper alloy, silver + thermoplastic on the top

- 控制盒符合 GB/T 20234.2-2015 控制原理
Control box meet GB/T 20234.2-2015 control principle
- 优越防护性能, 枪头防护等级达到 IP66 (工作状态), 控制盒防护等级达到 IP55/IP67 (工作状态)
Excellent protection performance, plug IP66 (working condition), PSE IP55/67 (working condition)

电气性能 Electrical Performance

- 额定电流电压: 220V AC 16A
Rated current and voltage: 220V AC 16A
- 绝缘电阻: > 1000MΩ (DC500V)
Insulation resistance: > 1000MΩ (DC500V)
- 端子温升: < 50K
Terminal temperature rise: < 50K
- 耐压: 2000V
Withstand Voltage: 2000V

控制盒功能 Control Box Function

- 漏电保护 (重启恢复)
Leakage protection (restart recover)
- 过压欠压保护 (自检恢复)
Overvoltage under-voltage protection (self-checking recover)
- 过载保护 (自检恢复)
Overload protection (self-checking recover)
- 防雷击保护
Lightning protection

产品选型与标准配线 Model selection and the standard wiring

型号 / Model	额定电流 / Rated current	线缆规格 / Cable specification
1180-PSE-16-XC-NS	16A	3 X 2.5mm ² + 2 X 0.75mm ²

CHARGING MODE 2

充电模式2

产品应用:电动汽车端电连接输入
Product application:Electric vehicle electrical connection

型号 Model:

● 2050-PSE-16-XC-ES



接线方式 Wiring mode

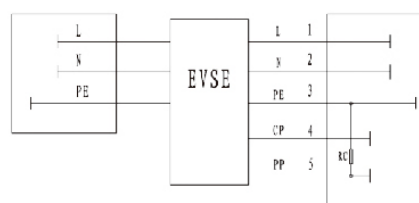

快速代码 Speed code: 2050

产品特点 Features

- 充电插座符合 62196-2 IEC 2010 SHEET 2-IIE 标准
Charging plug meet 62196-2 IEC 2010 SHEET 2-IIE standard
- 电源插头符合 DIN VED 0620-1 标准
Power plug meet DIN VED 0620-1 standard

机械性能 Mechanical properties

- 机械寿命: 空载拔插 > 10000 次
Mechanical life: no-load plug in/pull out > 10000 times
- 抗冲击力: 可承受 1 米高度跌落与 2 吨车辆碾压压力
Impact of external force: can afford 1m drop and 2t vehicle run over pressure

环境性能 Environmental performance

- 工作环境温度: -30°C ~ +50°C
Operating temperature: -30°C ~ +50°C

材料应用 Applied Materials

- 外壳材料: 热塑性塑料, 阻燃等级 UL94 V-0
Case Material: Thermoplastic, flame retardant grade UL94 V-0
- 插套: 铜合金, 表面镀银 + 顶部热塑性塑料
Contact bush: Copper alloy, silver + thermoplastic on the top

- 控制盒符合 IEC 61851-1 2010 控制原理
Control box meet IEC 61851-1 2010 control principle
- 优越防护性能, 枪头防护等级达到 IP44 (工作状态), 控制盒防护等级达到 IP55/IP67 (工作状态)
Excellent protection performance, plug IP44 (working condition), PSE IP55/67 (working condition)

电气性能 Electrical Performance

- 额定电流电压: 250V AC 16A
Rated current and voltage: 250V AC 16A
- 绝缘电阻: > 1000MΩ (DC500V)
Insulation resistance: > 1000MΩ (DC500V)
- 端子温升: < 50K
Terminal temperature rise: < 50K
- 耐压: 2000V
Withstand Voltage: 2000V

控制盒功能 Control Box Function

- 漏电保护 (重启恢复)
Leakage protection (restart recover)
- 过压欠压保护 (自检恢复)
Overvoltage under-voltage protection (self-checking recover)
- 过载保护 (自检恢复)
Overload protection (self-checking recover)
- 防雷击保护
Lightning protection

产品选型与标准配线 Model selection and the standard wiring

型号 / Model	额定电流 / Rated current	线缆规格 / Cable specification
2050-PSE-16-XC-ES	16A	3 X 2.5mm ² + 2 X 0.5mm ²

CHARGING MODE 2

充电模式2

产品应用: 电动汽车端电连接输入
Product application: Electric vehicle electrical connection

型号 Model:

● 2080-PSE-16-XC-ES



接线方式 Wiring mode

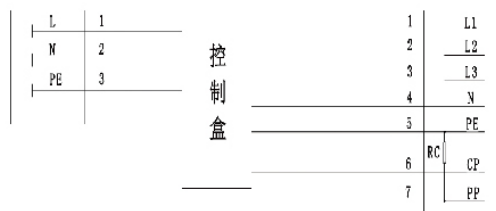

快速代码 Speed code: 2080

- 充电插头符合 62196-2 IEC2010 SHEETZ-IIIE 标准
Charging plug meet 62196-2 IEC2010 SHEETZ-IIIE standard
- 电源插头符合 GB 2099.1-2008 规定及要求, 可选择搭载温度保护装置
Power plug meet GB 2099.1-2008 regulations and requirements, can choose with temperature protection device

机械性能 Mechanical properties

- 机械寿命: 空载拔插 > 10000 次
Mechanical life: no-load plug in/pull out > 10000 times
- 抗冲击力: 可承受 1 米高度跌落与 2 吨车辆碾压力
Impact of external force: can afford 1m drop and 2t vehicle run over pressure

环境性能 Environmental performance

- 工作环境温度: -30°C ~ +50°C
Operating temperature: -30°C ~ +50°C

材料应用 Applied Materials

- 外壳材料: 热塑性塑料, 阻燃等级 UL94 V-0
Case Material: Thermoplastic, flame retardant grade UL94 V-0
- 插套: 铜合金, 表面镀银 + 顶部热塑性塑料
Contact bush: Copper alloy, silver + thermoplastic on the top

- 控制盒符合 GB/T 20234.2-2011 控制原理
Control box meet GB/T 20234.2-2011 control principle
- 优越防护性能, 枪头防护等级达到 IP54 (工作状态), 控制盒防护等级达到 IP55/IP67 (工作状态)
Excellent protection performance, plug IP54 (working condition), PSE IP55/67 (working condition)

电气性能 Electrical Performance

- 额定电流电压: 250V AC 16A
Rated current and voltage: 250V AC 16A
- 绝缘电阻: > 1000MΩ (DC500V)
Insulation resistance: > 1000MΩ (DC500V)
- 端子温升: < 50K
Terminal temperature rise: < 50K
- 耐压: 2000V
Withstand Voltage: 2000V

控制盒功能 Control Box Function

- 漏电保护 (重启恢复)
Leakage protection (restart recover)
- 过压欠压保护 (自检恢复)
Overvoltage under-voltage protection (self-checking recover)
- 过载保护 (自检恢复)
Overload protection (self-checking recover)
- 防雷击保护
Lightning protection

产品选型与标准配线 Model selection and the standard wiring

型号 / Model	额定电流 / Rated current	线缆规格 / Cable specification
2080-PSE-16-XC-ES	16A	3 X 2.5mm ² + 2 X 0.5mm ²

CHARGING MODE 2

充电模式2

产品应用: 电动汽车端电连接输入
Product application: Electric vehicle electrical connection

型号 Model:

● 3030-PSE-16-XC-AS



接线方式 Wiring mode

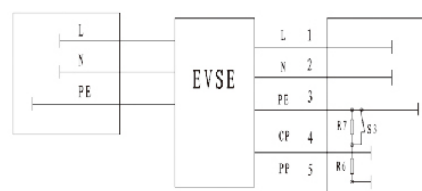

快速代码 Speed code: 3030

产品特点 Features

- 充电插头符合 SEA J1772 2010 标准
Charging plug meet SEA J1772 2010 standard
- 电源插头符合 NEMA 5-15 标准
Power plug meet NEMA 5-15 standard

- 控制盒符合 SEA J1772 2010 控制原理
Control box meet SEA J1772 2010 control principle
- 优越防护性能, 枪头防护等级达到 IP44(工作状态), 控制盒防护等级达到 IP55/IP67(工作状态)
Excellent protection performance, plug IP44(working condition), PSE IP55/67(working condition)

机械性能 Mechanical properties

- 机械寿命: 空载拔插 > 10000 次
Mechanical life : no-load plug in/pull out > 10000 times
- 抗冲击力: 可承受 1 米高度跌落与 2 吨车辆碾压力
Impact of external force: can afford 1m drop and 2t vehicle run over pressure

电气性能 Electrical Performance

- 额定电流电压: 110V~240V AC 16A
Rated current and voltage : 110V ~240V AC 16A
- 绝缘电阻: >1000MΩ(DC500V)
Insulation resistance: >1000MΩ(DC500V)
- 端子温升: <50K
Terminal temperature rise : <50K
- 耐压: 2000V
Withstand Voltage : 2000V

环境性能 Environmental performance

- 工作环境温度: -30°C ~+50°C
Operating temperature: -30°C~+50°C

控制盒功能 Control Box Function

- 漏电保护(重启恢复)
Leakage protection(restart recover)
- 过压欠压保护(自检恢复)
Overvoltage under-voltage protection(self-checking recover)
- 过载保护(自检恢复)
Overload protection(self-checking recover)
- 防雷击保护
Lightning protection

材料应用 Applied Materials

- 外壳材料: 热塑性塑料, 阻燃等级 UL94V-0
Case Material: Thermoplastic, flame retardant grade UL94 V-0
- 插套: 铜合金, 表面镀银 + 顶部热塑性塑料
Contact bush: Copper alloy, silver + thermoplastic on the top

产品选型与标准配线 Model selection and the standard wiring

型号 /Model	额定电流 /Rated current	线缆规格 /Cable specification
3030-PSE-16-XC-AS	16A	3 X 14AWG + 1 X 18AWG

CHARGING MODE 2

充电模式2

产品应用: 电动汽车端电连接输入
Product application: Electric vehicle electrical connection

型号 Model:

● 3050-PSE-16-XC-AS



接线方式 Wiring mode

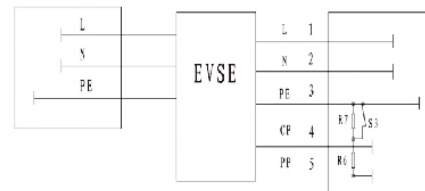

快速代码 Speed code: 3050

产品特点 Features

- 充电插头符合 SEA J1772 2010 标准
Charging plug meet SEA J1772 2010 standard
- 电源插头符合 NEMA 5-15 标准
Power plug meet NEMA 5-15 standard

机械性能 Mechanical properties

- 机械寿命: 空载拔插 > 10000 次
Mechanical life : no-load plug in/pull out > 10000 times
- 抗冲击力: 可承受 1 米高度跌落与 2 吨车辆碾压力
Impact of external force: can afford 1m drop and 2t vehicle run over pressure

环境性能 Environmental performance

- 工作环境温度: -30°C ~ +50°C
Operating temperature: -30°C ~ +50°C

材料应用 Applied Materials

- 外壳材料: 热塑性塑料, 阻燃等级 UL94 V-0
Case Material: Thermoplastic, flame retardant grade UL94 V-0
- 插套: 铜合金, 表面镀银 + 顶部热塑性塑料
Contact bush: Copper alloy, silver + thermoplastic on the top

- 控制盒符合 SEA J1772 2010 控制原理
Control box meet SEA J1772 2010 control principle
- 优越防护性能, 枪头防护等级达到 4X(工作状态), 控制盒防护等级达到 IP55/IP67(工作状态)
Excellent protection performance, plug 4X(working condition), PSE IP55/67(working condition)

电气性能 Electrical Performance

- 额定电流电压: 110V~240V AC 16A
Rated current and voltage : 110V~240V AC 16A
- 绝缘电阻: >1000MΩ(DC500V)
Insulation resistance: >1000MΩ(DC500V)
- 端子温升: <50K
Terminal temperature rise : <50K
- 耐压: 2000V
Withstand Voltage : 2000V

控制盒功能 Control Box Function

- 漏电保护(重启恢复)
Leakage protection(restart recover)
- 过压欠压保护(自检恢复)
Overvoltage under- voltage protection(self-checking recover)
- 过载保护(自检恢复)
Overload protection(self-checking recover)
- 防雷击保护
Lightning protection

产品选型与标准配线 Model selection and the standard wiring

型号 /Model	额定电流 /Rated current	线缆规格 /Cable specification
3050-PSE-16-XC-AS	16A	3 X 14AWG + 1 X 18AWG

CHARGING MODE 2

充电模式2

产品应用: 电动汽车端电连接输入
Product application: Electric vehicle electrical connection

型号 Model:

● 3050-PSE-32-XC-AS



接线方式 Wiring mode

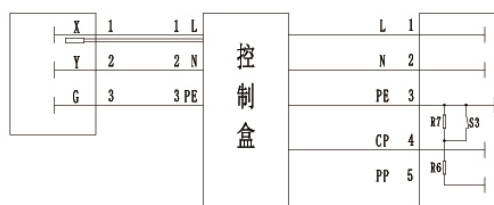

快速代码 Speed code: 3050

产品特点 Features

- 充电插头符合 SEA J1772 2010 标准
Charging plug meet SEA J1772 2010 standard
- 电源插头符合 NEMA 14-50 标准
Power plug meet NEMA 14-50 standard

机械性能 Mechanical properties

- 机械寿命: 空载拔插 >5000 次
Mechanical life: no-load plug in/pull out >5000 times
- 抗冲击力: 可承受 1 米高度跌落与 2 吨车辆碾压力
Impact of external force: can afford 1m drop and 2t vehicle run over pressure

环境性能 Environmental performance

- 工作环境温度: -30°C ~ +50°C
Operating temperature: -30°C ~ +50°C

材料应用 Applied Materials

- 外壳材料: 热塑性塑料, 阻燃等级 UL94 V-0
Case Material: Thermoplastic, flame retardant grade UL94 V-0
- 插套: 铜合金, 表面镀银 + 顶部热塑性塑料
Contact bush: Copper alloy, silver + thermoplastic on the top

- 控制盒符合 SEA J1772 2010 控制原理
Control box meet SEA J1772 2010 control principle
- 优越防护性能, 枪头防护等级达到 4X(工作状态), 控制盒防护等级达到 IP67(工作状态)
Excellent protection performance, plug 4X(working condition), PSE IP67(working condition)

电气性能 Electrical Performance

- 额定电流电压: 110V~240V AC 32A
Rated current and voltage: 110V~240V AC 32A
- 绝缘电阻: >1000MΩ(DC500V)
Insulation resistance: >1000MΩ(DC500V)
- 端子温升: <50K
Terminal temperature rise: <50K
- 耐压: 2000V
Withstand Voltage: 2000V

控制盒功能 Control Box Function

- 漏电保护(重启恢复)
Leakage protection(restart recover)
- 过压欠压保护(自检恢复)
Overvoltage under- voltage protection(self-checking recover)
- 过载保护(自检恢复)
Overload protection(self-checking recover)
- 防雷击保护
Lightning protection

产品选型与标准配线 Model selection and the standard wiring

型号 /Model	额定电流 /Rated current	线缆规格 /Cable specification
3050-PSE-32-XC-AS	32A	3 X 10AWG+ 1X 18AWG

CHARGING MODE 2

充电模式2

产品应用:电动汽车端电连接输入
Product application: Electric vehicle electrical connection

型号 Model:

2080-PSE-32-XC-ES



接线方式 Wiring mode

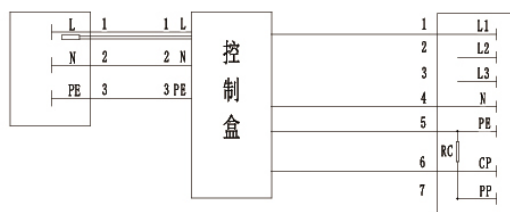

快速代码 Speed code: 2080

产品特点 Features

- 充电插头符合 62196-2 IEC2010 SHEETZ-IIIE 标准
Charging plug meet 62196-2 IEC2010 SHEETZ-IIIE standard
- 电源插头符合 IEC309 规定及要求,可选择搭载温度保护装置
Power plug meet IEC309 regulations and requirements,can choose with temperature protection device

机械性能 Mechanical properties

- 机械寿命: 空载拔插>10000 次
Mechanical life :no-load plug in/pull out>10000times
- 抗冲击力: 可承受 1 米高度跌落与 2 吨车辆碾压力
Impat of external force:can afford 1m and 2t vehicle run over pressure

环境性能 Environmental performance

- 工作环境温度: -30°C ~+50°C
Operating temperature:-30°C~+50°C

材料应用 Applied Materials

- 外壳材料: 热塑性塑料,阻燃等级 UL94 V-0
Case Material:Thermoplastic,flame retardant grade UL94V-0
- 插套: 铜合金,表面镀银+顶部热塑性塑料
Contact bush: Copper alloy,silver + thermoplastic on the top

- 控制盒符合 GB/T 20234.2-2011 控制原理
Control box meet GB/T 20234.2-2011 control principle
- 优越防护性能,枪头防护等级达到 IP54(工作状态),控制盒防护等级达到 IP67(工作状态)
Excellent protection performance, plug IP54(working condition), PSE IP67(working condition)

电气性能 Electrical Performance

- 额定电流电压: 220V AC 32A
Rated current and voltage :220V AC 32A
- 绝缘电阻: >1000MΩ (DC500V)
Insulation resistance: >1000MΩ(DC500V)
- 端子温升: <50K
Terminal temperature rise :<50K
- 耐压: 2000V
Withstand Voltage :2000V

控制盒功能 Control Box Function

- 漏电保护(重启恢复)
Leakage protection(restart recover)
- 过压欠压保护(自检恢复)
Overvoltage under- voltage protection(self-checking recover)
- 过载保护(自检恢复)
Overload protection(self-checking recover)
- 防雷击保护
Lightning protection

产品选型与标准配线 Model selection and the standard wiring

型号 /Model	额定电流 /Rated current	线缆规格 /Cable specification
2080-PSE-32-XC-ES	32A	3 X 6mm ² + 2 X 0.5mm ²

EV Conductive Charging Connection Assembly Option Guide EV传导充电用连接总成选型引导

充电模式3 CHARGING MODE 3

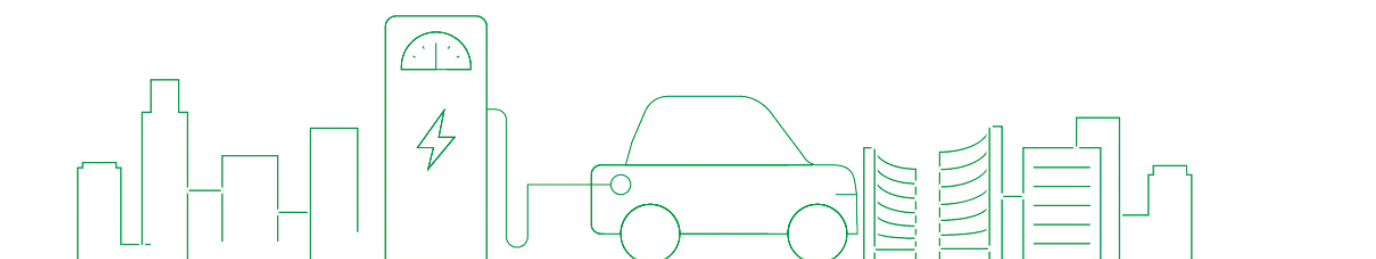
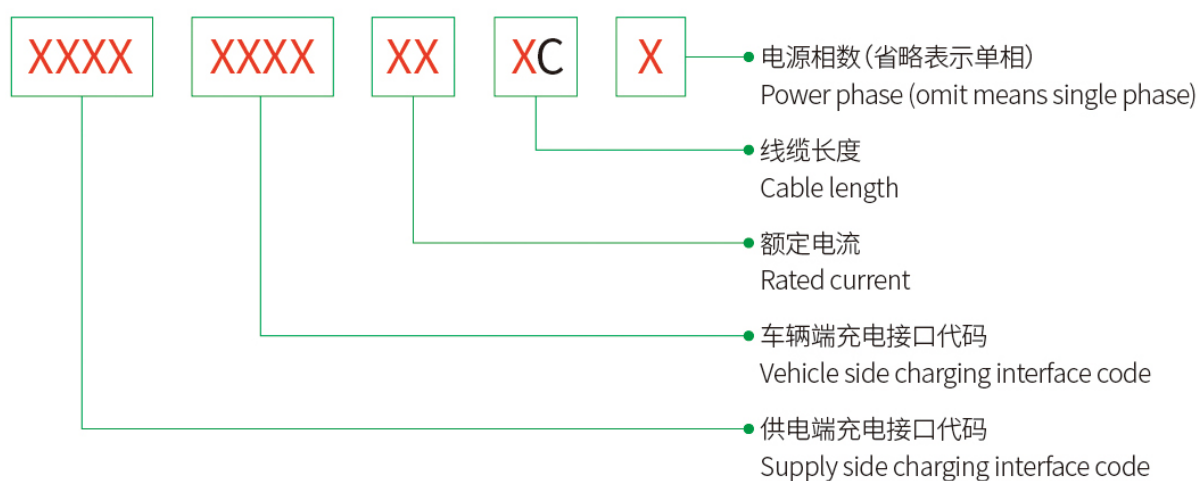

CHARGING MODE 3 CONNEVTION METHOD B

充电模式3 连接方式B

产品应用:充电桩至电动汽车电连接输入
Product application:Charging pile to electric vehicle electrical connection

型号 Model:

- 1040-1060-16-XC
- 1040-1060-32-XC



接线方式 Wiring mode

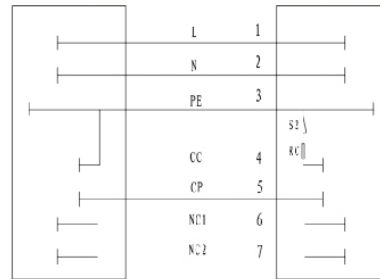

产品特点 Features

- 充电插头符合 GB/T 20234.2-2015 标准
Charging plug meet GB/T 20234.2-2015 standard
- 产品总成符合 GB/T 20234.2-2011 充电模式 3 连接模式 B
Product assembly meet GB/T 20234.2-2011 charging mode 3 connection method B

机械性能 Mechanical properties

- 机械寿命: 空载拔插 >10000 次
Mechanical life : no-load plug in/pull out >10000 times
- 抗冲击力: 可承受 1 米高度跌落与 2 吨车辆碾压力
Impat of external force: can afford 1m drop and 2t vehicle run over pressure

环境性能 Environmental performance

- 工作环境温度: -30°C ~+50°C
Operating temperature: -30°C~+50°C

材料应用 Applied Materials

- 外壳材料: 热塑性塑料, 阻燃等级 UL94 V-0
Case Material: Thermoplastic, flame retardant grade UL94 V-0
- 插针: 铜合金, 表面镀银 + 顶部热塑性塑料
Pin: Copper alloy, silver + thermoplastic on the top

- 外形美观, 手持式设计符合人体工程学原理, 插拔便捷
Nice appearance, hand design to prevent accidental diirect contact with staff
- 插针头部采用安全绝缘设计, 防止人手意外直接接触
Safety pins insulated head design to prevent accidental diirect contact with staff
- 优越防护性能, 防护等级达到 IP55 (工作状态)
Excellent protection performance, protection grade IP55 (working condition)

电气性能 Electrical Performance

- 额定工作电流: 16A 或 32A
Rated current : 16A or 32A
- 工作电压: 250V
Operation voltage: 250V
- 绝缘电阻: >1000MΩ (DC500V)
Insulation resistance: >1000MΩ (DC500V)
- 端子温升: <50K
Terminal temperature rise : <50K
- 耐压: 2000V
Withstand Voltage : 2000V
- 接触阻抗: 0.5mΩ Max
Contact Resistance: 0.5mΩ Max

产品选型与标准配线 Model selection and the standard wiring

型号 /Model	额定电流 /Rated current	线缆规格 /Cable specification
1040-1060-16-XC	16A	3 X 2.5mm ² + 2 X 0.75mm ²
1040-1060-32-XC	32A	3 X 6mm ² + 2 X 0.75mm ²

CHARGING MODE 3 CONNECTION METHOD B

充电模式3 连接方式B

产品应用: 充电桩至电动汽车电连接输入
Product application: Charging pile to electric vehicle electrical connection

型号 Model:

● 1160-1170-16-XC

● 1160-1170-32-XC



接线方式 Wiring mode

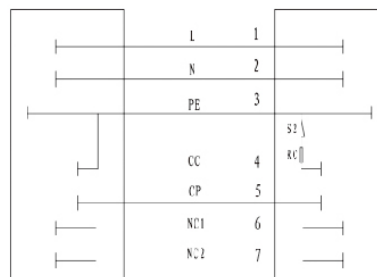

产品特点 Features

- 充电插头符合 GB/T 20234.2-2015 标准
Charging plug meet GB/T 20234.2-2015 standard
- 产品总成符合 GB/T 20234.2-2011 充电模式 3 连接模式 B
Product assembly meet GB/T 20234.2-2011 charging mode 3 connection method B

机械性能 Mechanical properties

- 机械寿命: 空载拔插 > 10000 次
Mechanical life: no-load plug in/pull out > 10000 times
- 抗冲击力: 可承受 1 米高度跌落与 2 吨车辆碾压压力
Impact of external force: can afford 1m drop and 2t vehicle run over pressure

环境性能 Environmental performance

- 工作环境温度: -30°C ~ +50°C
Operating temperature: -30°C ~ +50°C

材料应用 Applied Materials

- 外壳材料: 热塑性塑料, 阻燃等级 UL94 V-0
Case Material: Thermoplastic, flame retardant grade UL94 V-0
- 插针: 铜合金, 表面镀银 + 顶部热塑性塑料
Pin: Copper alloy, silver + thermoplastic on the top

产品选型与标准配线 Model selection and the standard wiring

型号 /Model	额定电流 /Rated current	线缆规格 /Cable specification
1160-1170-16-XC	16A	3 X 2.5mm ² + 2 X 0.75mm ²
1160-1170-32-XC	32A	3 X 6mm ² + 2 X 0.75mm ²

- 外形美观, 手持式设计符合人体工程学原理, 插拔便捷
Nice appearance, hand-held ergonomic design, easy plug
- 插针头部采用安全绝缘设计, 防止人手意外直接接触
Safety pins insulated head design to prevent accidental direct contact with staff
- 优越防护性能, 防护等级达到 IP55 (工作状态)
Excellent protection performance, protection grade IP55 (working condition)

电气性能 Electrical Performance

- 额定工作电流: 16A 或 32A
Rated current: 16A or 32A
- 工作电压: 250V
Operation voltage: 250V
- 绝缘电阻: > 1000MΩ (DC500V)
Insulation resistance: > 1000MΩ (DC500V)
- 端子温升: < 50K
Terminal temperature rise: < 50K
- 耐压: 2000V
Withstand Voltage: 2000V
- 接触阻抗: 0.5mΩ Max
Contact Resistance: 0.5mΩ Max

CHARGING MODE 3 CONNEVTION METHOD B

充电模式3 连接方式B

产品应用: 充电桩至电动汽车电连接输入

Product application: Charging pile to electric vehicle electrical connection

型号 Model:

● 1180-1190-16-XC

● 1180-1190-32-XC



接线方式 Wiring mode

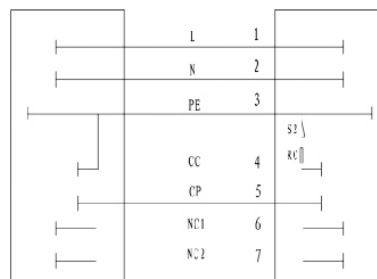

产品特点 Features

- 充电插头符合 GB/T 20234.2-2015 标准
Charging plug meet GB/T 20234.2-2015 standard
- 产品总成符合 GB/T 20234.2-2015 充电模式 3 连接模式 B
Product assembly meet GB/T 20234.2-2015 charging mode 3 connection method B

机械性能 Mechanical properties

- 机械寿命: 空载拔插 > 10000 次
Mechanical life: no-load plug in/pull out > 10000 times
- 抗冲击力: 可承受 1 米高度跌落与 2 吨车辆碾压力
Impat of external force: can afford 1m drop and 2t vehicle run over pressure

环境性能 Environmental performance

- 工作环境温度: -30°C ~ +50°C
Operating temperature: -30°C ~ +50°C

材料应用 Applied Materials

- 外壳材料: 热塑性塑料, 阻燃等级 UL94 V-0
Case Material: Thermoplastic, flame retardant grade UL94 V-0
- 插针: 铜合金, 表面镀银 + 顶部热塑性塑料
Pin: Copper alloy, silver + thermoplastic on the top

产品选型与标准配线 Model selection and the standard wiring

型号 /Model	额定电流 /Rated current	线缆规格 /Cable specification
1180-1190-16-XC	16A	3 X 2.5mm ² + 2 X 0.75mm ²
1180-1190-32-XC	32A	3 X 6mm ² + 2 X 0.75mm ²

- 外形美观, 手持式设计符合人体工程学原理, 插拔便捷
Nice appearance, hand-held ergonomic design, easy plug
- 插针头部采用安全绝缘设计, 防止人手意外直接接触
Safety pins insulated head design to prevent accidental diirect contact with staff
- 优越防护性能, 防护等级达到 IP66 (工作状态)
Excellent protection performance, protection grade IP66 (working condition)

电气性能 Electrical Performance

- 额定工作电流: 16A 或 32A
Rated current: 16A or 32A
- 工作电压: 250V
Operation voltage: 250V
- 绝缘电阻: > 1000MΩ (DC500V)
Insulation resistance: > 1000MΩ (DC500V)
- 端子温升: < 50K
Terminal temperature rise: < 50K
- 耐压: 2000V
Withstand Voltage: 2000V
- 接触阻抗: 0.5mΩ Max
Contact Resistance: 0.5mΩ Max

CHARGING MODE 3 CONNECTION METHOD B2 Type 2

充电模式3 连接方式B2 类型2

产品应用: 充电桩至电动汽车电连接输入
Product application: Charging pile to electric vehicle electrical connection

型号 Model:

- 2010-2050-16-XC
- 2010-2050-32-XC
- 2010-2050-16-XC-3
- 2010-2050-32-XC-3



接线方式 Wiring mode

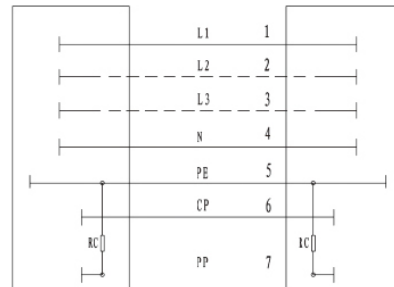

产品特点 Features

- 充电插座符合 62196-2 IEC 2010 SHEET 2-IIe 标准
Charging plug meet 62196-2 IEC 2010 SHEET 2-IIe standard
- 产品总成符合 IEC 61851-1 2010 充电模式 3 连接模式 B2
Product assembly meet IEC 61851-1 2010 charging mode 3 connection method B2

机械性能 Mechanical properties

- 机械寿命: 空载拔插 >10000 次
Mechanical life: no-load plug in/pull out >10000 times
- 抗冲击力: 可承受 1 米高度跌落与 2 吨车辆碾压力
Impact of external force: can afford 1m drop and 2t vehicle run over pressure

环境性能 Environmental performance

- 工作环境温度: -30°C ~+50°C
Operating temperature: -30°C ~+50°C

材料应用 Applied Materials

- 外壳材料: 热塑性塑料, 阻燃等级 UL94 V-0
Case Material: Thermoplastic, flame retardant grade UL94 V-0
- 插套: 铜合金, 表面镀银
Contact bush: Copper alloy, silver plating

产品选型与标准配线 Model selection and the standard wiring

型号 /Model	额定电流 /Rated current	线缆规格 /Cable specification
2010-2050-16-XC	16A	3 X 2.5mm ² + 2 X 0.5mm ²
2010-2050-32-XC	32A	3 X 6mm ² + 2 X 0.5mm ²
2010-2050-16-XC-3	16A	5 X 2.5mm ² + 2 X 0.5mm ²
2010-2050-32-XC-3	32A	5 X 6mm ² + 2 X 0.5mm ²

- 外形美观, 手持式设计符合人体工程学原理, 插拔便捷
Nice appearance, hand-held ergonomic design, easy plug
- 可靠性材料, 阻燃、耐压、耐磨、耐冲击、高抗油
Reliability of materials, antifracking, pressure-resistant, abrasion resistance, impact resistance and high oil.
- 优越防护性能, 防护等级达到 IP44 (工作状态)
Excellent protection performance, protection grade IP44 (working condition)

电气性能 Electrical Performance

- 额定工作电流: 16A 或 32A
Rated current: 16A or 32A
- 工作电压: 250V/415V
Operation voltage: 250V/415V
- 绝缘电阻: >1000MΩ (DC500V)
Insulation resistance: >1000MΩ (DC500V)
- 端子温升: <50K
Terminal temperature rise: <50K
- 耐压: 2000V
Withstand Voltage: 2000V
- 接触阻抗: 0.5mΩ Max
Contact Resistance: 0.5mΩ Max

CHARGING MODE 3 CONNECTION METHOD B2 Type 2

充电模式3 连接方式B2 类型2

产品应用: 充电桩至电动汽车电连接输入
Product application: Charging pile to electric vehicle electrical connection

型号 Model:

- 2080-2090-16-XC
- 2080-2090-32-XC
- 2080-2090-16-XC-3



接线方式 Wiring mode

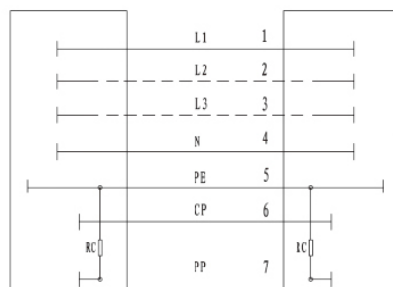

产品特点 Features

- 充电插座符合 62196-2 IEC 2010 SHEET 2-IIe 标准
Charging plug meet 62196-2 IEC 2010 SHEET 2-IIe standard
- 产品总成符合 IEC 61851-1 2010 充电模式 3 连接模式 B2
Product assembly meet IEC 61851-1 2010 charging mode 3 connection method B2

机械性能 Mechanical properties

- 机械寿命: 空载拔插 > 10000 次
Mechanical life: no-load plug in/pull out > 10000 times
- 抗冲击力: 可承受 1 米高度跌落与 2 吨车辆碾压压力
Impact of external force: can afford 1m drop and 2t vehicle run over pressure

环境性能 Environmental performance

- 工作环境温度: -30°C ~ +50°C
Operating temperature: -30°C ~ +50°C

材料应用 Applied Materials

- 外壳材料: 热塑性塑料, 阻燃等级 UL94 V-0
Case Material: Thermoplastic, flame retardant grade UL94-0
- 插套: 铜合金, 表面镀银
Contact bush: Copper alloy, silver plating

- 外形美观, 手持式设计符合人体工程学原理, 插拔便捷
Nice appearance, hand-held ergonomic design, easy plug
- 可靠性材料, 阻燃、耐压、耐磨、耐冲击、高抗油
Reliability of materials, antflaming, pressure-resistant, abrasion resistance, impact resistance and high oil.
- 优越防护性能, 防护等级达到 IP54 (工作状态)
Excellent protection performance, protection grade IP54 (working condition)

电气性能 Electrical Performance

- 额定工作电流: 16A 或 32A
Rated current: 16A or 32A
- 工作电压: 250V / 415V
Operation voltage: 250V / 415V
- 绝缘电阻: > 1000MΩ (DC500V)
Insulation resistance: > 1000MΩ (DC500V)
- 端子温升: < 50K
Terminal temperature rise: < 50K
- 耐压: 2000V
Withstand Voltage: 2000V
- 接触阻抗: 0.5mΩ Max
Contact Resistance: 0.5mΩ Max

产品选型与标准配线 Model selection and the standard wiring

型号 / Model	额定电流 / Rated current	线缆规格 / Cable specification
2080-2090-16-XC	16A	3 X 2.5mm ² + 2 X 0.5mm ²
2080-2090-32-XC	32A	3 X 6mm ² + 2 X 0.5mm ²
2080-2090-16-XC-3	16A	5 X 2.5mm ² + 2 X 0.5mm ²

CHARGING MODE 3 CONNECTION METHOD B2 Type 1

充电模式3 连接方式B2 类型1

产品应用: 充电桩至电动汽车电连接输入
Product application: Charging pile to electric vehicle electrical connection

型号 Model:

- 2010-3030-16-XC
- 2010-3030-32-XC

接线方式 Wiring mode

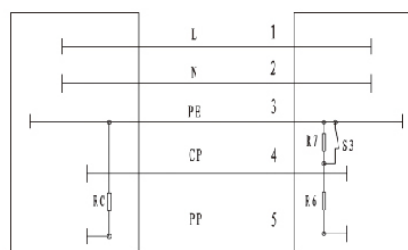

产品特点 Features

- 充电插座符合 62196-2 IEC 2010 SHEET 2-IIe 标准
Charging plug meet 62196-2 IEC 2010 SHEET 2-IIe standard
- 产品总成符合 IEC 61851-1 2010 充电模式 3 连接模式 B2
Product assembly meet IEC 61851-1 2010 charging mode 3 connection method B2

机械性能 Mechanical properties

- 机械寿命: 空载拔插 > 10000 次
Mechanical life: no-load plug in/pull out > 10000 times
- 抗冲击力: 可承受 1 米高度跌落与 2 吨车辆碾压压力
Impact of external force: can afford 1m drop and 2t vehicle run over pressure

环境性能 Environmental performance

- 工作环境温度: -30°C ~ +50°C
Operating temperature: -30°C ~ +50°C

材料应用 Applied Materials

- 外壳材料: 热塑性塑料, 阻燃等级 UL94 V-0
Case Material: Thermoplastic, flame retardant grade UL94 V-0
- 插套: 铜合金, 表面镀银
Contact bush: Copper alloy, silver plating

- 外形美观, 手持式设计符合人体工程学原理, 插拔便捷
Nice appearance, hand-held ergonomic design, easy plug
- 可靠性材料, 阻燃、耐压、耐磨、耐冲击、高抗油
Reliability of materials, antifracking, pressure-resistant, abrasion resistance, impact resistance and high oil
- 优越防护性能, 防护等级达到 IP44 (工作状态)
Excellent protection performance, protection grade IP44 (working condition)

电气性能 Electrical Performance

- 额定工作电流: 16A 或 32A
Rated current: 16A or 32A
- 工作电压: 250V
Operation voltage: 250V
- 绝缘电阻: >1000MΩ (DC500V)
Insulation resistance: >1000MΩ (DC500V)
- 端子温升: <50K
Terminal temperature rise: <50K
- 耐压: 2000V
Withstand Voltage: 2000V
- 接触阻抗: 0.5mΩ Max
Contact Resistance: 0.5mΩ Max

产品选型与标准配线 Model selection and the standard wiring

型号 / Model	额定电流 / Rated current	线缆规格 / Cable specification
2010-3030-16-XC	16A	3 X 2.5mm ² + 2 X 0.5mm ²
2010-3030-32-XC	32A	3 X 6mm ² + 2 X 0.5mm ²

CHARGING MODE 3 CONNEVTION METHOD B2 Type 2

充电模式3 连接方式B2 类型2

产品应用:充电桩至电动汽车电连接输入
Product application:Charging pile to electric vehicle electrical connection

型号 Model:

- 2090-3050-16-XC
- 2090-3050-32-XC



接线方式 Wiring mode

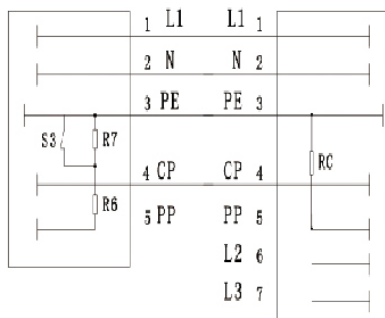

产品特点 Features

- 充电插座符合 62196-2 IEC 2010 SHEET 2-IIe 标准 ;SAE J1772 2010 标准
Charging plug meet 62196-2 IEC 2010 SHEET 2-IIe standard ; SAE J1772 2010 standard
- 产品总成符合 IEC 61851-1 2010 充电模式 3 连接模式 B2
Product assembly meet IEC 61851-1 2010 charging mode 3 connection method B2

机械性能 Mechanical properties

- 机械寿命: 空载拔插 >10000 次
Mechanical life : no-load plug in/pull out >10000 times
- 抗冲击力: 可承受 1 米高度跌落与 2 吨车辆碾压力
Impat of external force: can afford 1m drop and 2t vehicle run over pressure

环境性能 Environmental performance

- 工作环境温度: -30°C ~+50°C
Operating temperature: -30°C ~+50°C

材料应用 Applied Materials

- 外壳材料: 热塑性塑料,阻燃等级 UL94 V-0
Case Material: Thermoplastic,flame retardant grade UL94 V-0
- 插套: 铜合金,表面镀银
Contact bush: Copper alloy,silver plating

- 外形美观,手持式设计符合人体工程学原理,插拔便捷
Nice appearance, hand-held ergonomic design, easy plug
- 可靠性材料,阻燃、耐压、耐磨、耐冲击、高抗油
Reliability of materials, antflaming, pressure-resistant, abrasion resistance, impact resistance and high oil.
- 优越防护性能,防护等级达到 IP54(工作状态)
Excellent protection performance,protection grade IP54(working condition)

电气性能 Electrical Performance

- 额定工作电流: 16A 或 32A
Rated current : 16A or 32A
- 工作电压: 250V
Operation voltage: 250V
- 绝缘电阻: >1000MΩ(DC500V)
Insulation resistance: >1000MΩ(DC500V)
- 端子温升: <50K
Terminal temperature rise : <50K
- 耐压: 2000V
Withstand Voltage : 2000V
- 接触阻抗: 0.5mΩ Max
Contact Resistance: 0.5mΩ Max

产品选型与标准配线 Model selection and the standard wiring

型号 /Model	额定电流 /Rated current	线缆规格 /Cable specification
2090-3050-16-XC	16A	3 X 2.5mm ² + 2 X 0.5mm ²
2090-3050-32-XC	32A	3 X 6mm ² + 2 X 0.5mm ²

CHARGING MODE 3 CHARGING PILE

充电模式3 充电桩

产品应用:充电桩

Product application:Charging pile

型号 Model:

● 2080-SES-16-0

● 2080-SES-32-0



技术规格 Technical specifications

- 安装方式: 立桩式 / 壁挂式
Installation method: stake-type / wall-mounted
- 最大功率: 7KW
Maximum power: 7KW
- 通信接口: GPRS/WIFI(选配)
Communication interface: GPRS/WIFI (optional)
- 室外防护: IP55
Outdoor protection: IP55
- 安全规范: 符合 IEC 61851 和 IEC 62196 标准以及最新 GB/T 18487 和 GB/T 20234 标准
Safety specifications: Conforms to the latest IEC 61851 and IEC 62196 standards and the latest GB/T 18487 and GB/T 20234 standards
- 工作温度: 环境温度 -30°C到 50°C
Operating temperature: ambient temperature -30°C to 50°C

输出类型 Output type

- GB/T 18487-2015 模式 3
GB/T 18487-2015 mode 3
- IEC 61851 Type 2 / Type 3
- 7KW: 220VAC@32A
7KW: 220VAC@32A

基本功能 Basic skills

- 启动方式: 即插即充、RFID 卡
Start method: plug and charge, RFID card
- 提醒功能: 充电指示、故障指示
Remind function: charge indication, fault indication
- 自测试功能: 故障自定位
Self-test function: fault self-positioning
- 人机交互: LED 显示屏(选配)
Human-computer interaction: LED display (optional)

安全防护 Security

- 双重漏电检测与保护
Leakage detection and protection
- 急停按钮防护
Emergency stop button protection
- 过流、过压、欠压、过温度保护
Over-current, over-voltage, under-voltage, over-temperature protection
- 断电数据记录
Power failure data records
- 浪涌保护符合最新 IEC 61851 & GB/T 18487 标准
Surge protection meets latest IEC 61851 & GB/T 18487 standards
- 电磁兼容符合最新 IEC 61851 & GB/T 18487 标准
Electromagnetic compatibility complies with the latest IEC 61851 & GB/T 18487 standards

CHARGING MODE 3 CHARGING PILE

充电模式3 充电桩

产品应用: 充电桩至电动汽车电连接输入
Product application: Charging pile to electric vehicle electrical connection

型号 Model:

- 2080-SEL-16-5R
- 2080-SEL-32-5R



技术规格 Technical specifications

- 安装方式: 立柱式 / 壁挂式
Installation method: stake-type / wall-mounted
- 最大功率: 7KW@AC220V
Maximum power: 7KW@AC220V
- 通信接口: GPRS/WIFI;
Communication interface: GPRS/WIFI; Extensible RS485
- 室外防护: IP55
Outdoor protection: IP55
- 安全规范: 符合最新 IEC 61851 和 IEC 62196 标准以及最新 GB/T 18487 和 GB/T 20234 标准
Meet the latest IEC 61851 and IEC 62196 standards and the latest GB/T 18487 and GB/T 20234 standards
- 工作温度: 环境温度 -30°C到 50°C
Operating temperature: ambient temperature -30°C to 50°C

输出类型 Output type

- GB/T 18487-2015 模式 3
GB/T 18487-2015 mode 3
IEC 61851 Type 2 / Type 3
- 7KW: 220VAC@32A
7KW: 220VAC@32A

基本功能 Basic skills

- 启动方式: 即插即充、RFID 卡、手机 APP
Start mode: plug and charge, RFID card, mobile APP
- 电能计量: 1.0 级电能计量表
Energy metering: Class 1.0 energy meter
- 提醒功能: 充电指示、故障指示、APP 充电状态提醒
Remind function: charge indication, fault indication, APP charge status remind
- 自测试功能: 故障自定位
Self-test function: fault self-positioning
- 人机交互: 5 寸 /8 寸电容触摸屏
Human-computer interaction: 5 inch/8 inch capacitive touch screen
- 无线通信: 后台 GPRS 通信 / WIFI
Wireless Communication: Background GPRS Communication

安全防护 Security

- 双重漏电防护(主板漏电检测保护)
Double leakage protection (main board leakage detection protection)
- 双重防雷防护(专业防雷器 + 防雷保护电路)
Double Lightning Protection (Professional SPD + Lightning Protection Circuit)
- 急停按钮防护
Emergency stop button protection
- 过流、过压、欠压、过温度保护
Over-current, over-voltage, under-voltage, over-temperature protection
- 断电数据记录
Power failure data record
- 浪涌保护符合最新 IEC 61851 & GB/T 18487 标准
Surge protection meets latest IEC 61851 & GB/T 18487 standards
- 电磁兼容符合最新 IEC 61851 & GB/T 18487 标准
Electromagnetic compatibility complies with the latest IEC 61851 & GB/T 18487 standards

ELECTROMAGNETIC LOCK

电锁

产品应用:防止充电插头意外脱开
Product application: Prevent charging plug release accidentally

型号 Model:

● RHTEC-ELM

外形尺寸 Appearance dimensions

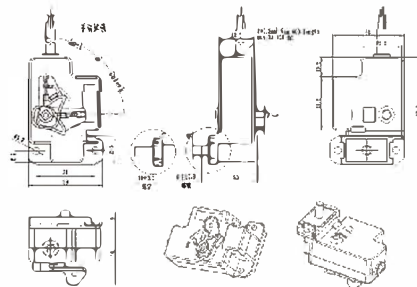
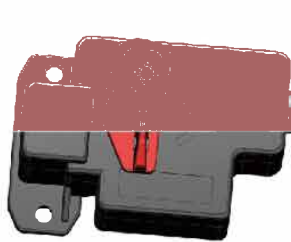

控制接线 Control Wiring

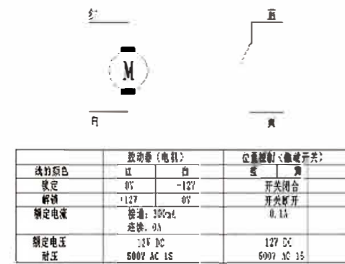

产品特点 Features

- 瞬间供电模式,低能源损耗
Instantaneous power supply mode, low energy loss
- 体积小,适合狭小空间安装
Small size, suitable for small space installation
- 停电或故障可人工解锁
Power failure or malfunction can be manual release
- 不可拆外壳防护,防护等级 IP55
Non-detachable shell protection, protection grade IP55

机械性能 Mechanical properties

- 机械寿命: 工作循环 > 50000 次
Mechanical life: operating cycle > 50000 times

环境性能 Environmental performance

- 工作环境温度: -30°C ~ +70°C
Operating temperature: -30°C ~ +70°C

材料应用 Applied Materials

- 外壳材料: 热塑性塑料,阻燃等级 UL94 HB
Case Material: Thermoplastic, flame retardant grade UL94 HB

电气性能 Electrical Performance

- 电流: 0.3A
Current: 0.3A
- 电压: 12V DC
Voltage: 12V DC
- 功率: 3.6W
Power: 3.6W
- 使用电压范围: 6/12V DC
Operating voltage range: 6/12V DC
- 耐压: 500V AC 1S
Withstand Voltage: 500V AC 1S
- 工作循环: 激活 < 300 毫秒,持续 3 秒 MAX
Working cycle: On: Activate < 300 ms for 3 seconds MAX

产品选型与标准配线 Model selection and the standard wiring

型号 /Model	额定电流 /Rated current	线缆规格 /Cable specification	线长 /Cable length	线径 /Wire diameter	颜色 /Colour
RHTEC-ELM	12V 0.3A	4 X 0.25mm ²	600mm	4mm	黑色 /Black

ELECTROMAGNETIC LOCK

电锁

型号 Model:

产品应用:防止充电插头意外脱开
Product application: Prevent charging plug release accidentally

- V4Z-**R** HT-EL
可适配产品 Adapt for:
- 1130/1090



快速代码 Speed code: 6050

外形尺寸 Appearance dimensions

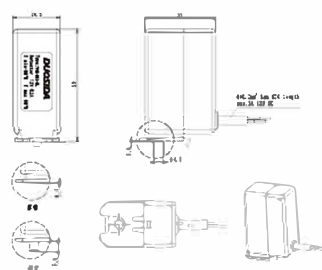

控制接线 Control Wiring

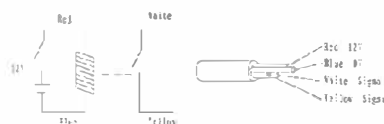

wire color	ac (unpowered)	pos. (on)	pos. (off)	signal
Red	12V	0V	0V	Signal
Blue	0V	12V	0V	Signal
White	0V	0V	0V	Signal
Yellow	0V	0V	0V	Signal

activation time < 300 ms
Temperature Range -30°C~+70°C

产品特点 Features

- 瞬间供电模式,低能源损耗
Instantaneous power supply mode, low energy loss
- 体积小,适合狭小空间安装
Small size, suitable for small space installation
- 停电或故障可人工解锁
Power failure or malfunction can be manual release
- 不可拆外壳防护,防护等级 IP55
Non-detachable shell protection, protection grade IP55

机械性能 Mechanical properties

- 机械寿命: 工作循环 > 50000 次
Mechanical life: operating cycle > 50000 times

环境性能 Environmental performance

- 工作环境温度: -30°C ~ +70°C
Operating temperature: -30°C ~ +70°C

材料应用 Applied Materials

- 外壳材料: 热塑性塑料,阻燃等级 UL94 HB
Case Material: Thermoplastic, flame retardant grade UL94 HB

电气性能 Electrical Performance

- 电流: 3A/1.5A
Current: 3A/1.5A
- 电压: 12V/24V DC
Voltage: 12V/24V DC
- 功率: 36W
Power: 36W
- 使用电压范围: 12V/24V DC
Operating voltage range: 12V/24V DC
- 耐压: 1000V
Withstand Voltage: 1000V
- 工作循环: 5%ED 激活 < 300 毫秒,持续 3 秒 MAX
Working cycle: On: 5%ED activation < 300 ms, continue 3 seconds max
- 绝缘等级: E 类
Insulation class: E(class)

产品选型与标准配线 Model selection and the standard wiring

型号 / Model	额定电流 / Rated current	线缆规格 / Cable specification
V4Z- R HT-EL	12V 3A	4 X 0.25mm ²
	24V 1.5A	4 X 0.25mm ²

Electromagnetic lock 电锁

产品应用:防止充电插头意外脱开
Product application: Prevent charging plug release accidentally

型号 Model:

● V4CRHt-ELM

外形尺寸 Appearance dimensions

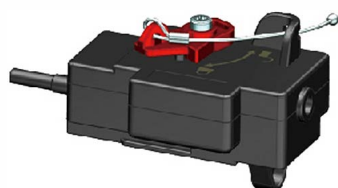

快速代码 Speed code: 6070

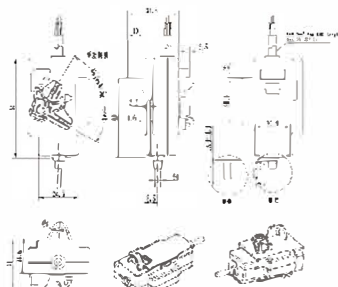

控制接线 Control Wiring

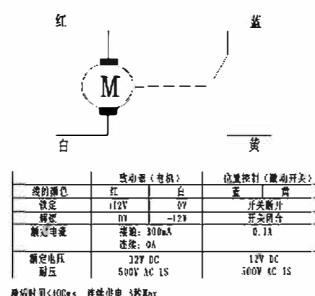

产品特点 Features

- 瞬间供电模式, 低能源损耗
Instantaneous power supply mode, low energy loss
- 体积小, 适合狭小空间安装
Small size, suitable for small space installation

机械性能 Mechanical properties

- 机械寿命: 工作循环 > 50000 次
Mechanical life: operating cycle > 50000 times

环境性能 Environmental performance

- 工作环境温度: -30°C ~ +50°C
Operating temperature: -30°C ~ +50°C

材料应用 Applied Materials

- 外壳材料: 热塑性塑料, 阻燃等级 UL94 HB
Case Material: Thermoplastic, flame retardant grade UL94 HB

- 停电或故障可人工解锁
Power failure or malfunction can be manual release
- 不可拆外壳防护, 防护等级 IP55
Non-detachable shell protection, protection grade IP55

电气性能 Electrical Performance

- 电流: 0.3A
Current: 0.3A
- 电压: 12V DC
Voltage: 12V DC
- 功率: 3.6W
Power: 3.6W
- 使用电压范围: 6V/12V DC
Operating voltage range: 6V/12V DC
- 耐压: 500V AC 1S
Withstand Voltage: 500V AC 1S
- 工作循环: 激活 < 300 毫秒, 持续 3 秒 MAX
Working cycle: On: activation < 300 ms, continue 3 seconds max

产品选型与标准配线 Model selection and the standard wiring

型号 /Model	额定电流 /Rated current	线缆规格 /Cable specification	线长 /Cable length	线径 /Wire diameter	颜色 /Colour
V4CR Ht-ELM	12V 0.3A	4 X 0.25mm ²	600mm	4mm	黑色 /Black

Plug dummy socket 插头固定座系列

型号 Model: 7010

GB交流插头固定座
GB AC plug dummy socket



型号 Model: 7020

GB交流插头固定座
GB AC plug dummy socket



型号 Model: 7030

GB直流插头固定座
GB DC plug dummy socket



型号 Model: 7040

GB直流插头固定座
GB DC plug dummy socket



型号 Model: 7050

SAE交流插头固定座
SAE AC plug dummy socket



型号 Model: 7060

IEC交流插头固定座
IEC AC plug dummy socket



型号 Model: 7070

GB直流插头固定座
GB DC plug dummy socket



型号 Model: 7080

COMBO 2 插头固定座
COMBO 2 plug dummy socket



CCS1 to CCS2

产品应用:电动汽车端电连接输入
Product application:Electric vehicle electrical connection

型号 Model:

● 25135

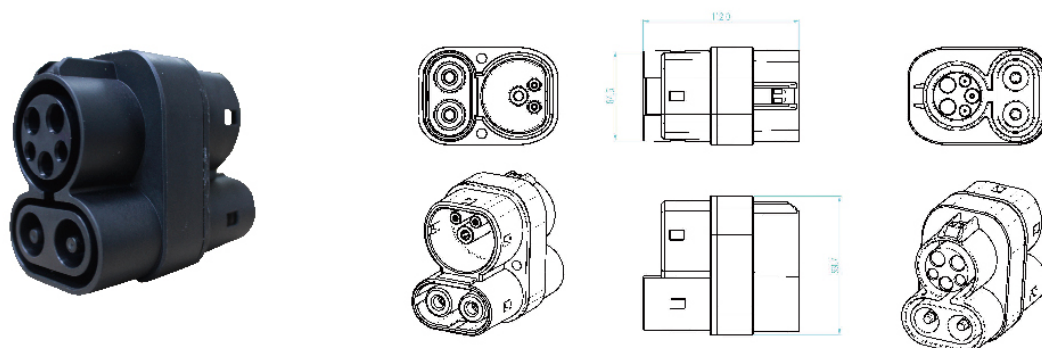

产品特点 Features

- 符合 IEC 62196-3: 2014 标准

Comply with IEC 62196-3: 2014 standards

机械性能 Mechanical properties

- 机械寿命: 空载拔插 > 5000 次

Mechanical life: > unplugged 5000 times

环境性能 Environmental performance

- 工作环境温度: -30°C~+50°C

Operating temperature: -30°C~+50°C

材料应用 Applied Materials

- 外壳材料: 热塑性塑料, 阻燃等级 UL94 V-0

Case Material: thermoplastic, flame retardant grade UL94 V-0

- 端子: 铜合金, 表面镀银

Terminal: copper alloy, silver plated surface

- 内芯: 热塑性塑料

Inner core: thermoplastic

- 优越的防护性能, 防护等级达到 IP67 (产品内部)

Excellent protection performance, protection grade IP67 (inside the product)

电气性能 Electrical Performance

- 额定工作电流: Max 150A

Rated operating current: Max 150A

- 工作电压: 1000V DC

Working voltage: 1000V DC

- 绝缘电阻: > 1000MΩ (DC500V)

Insulation resistance: > 1000 mΩ (DC500V)

- 端子升温: < 45K

Terminal temperature rise: < 45K

- 耐压: 3200V/DC

Withstand voltage: 3200 v/DC

- 接触阻抗: 0.3mΩ

Contact resistance: 0.3 mΩ

Adapter

产品应用: 电动汽车端电连接输入
Product application: Electric vehicle electrical connection

型号 Model:
● 35125

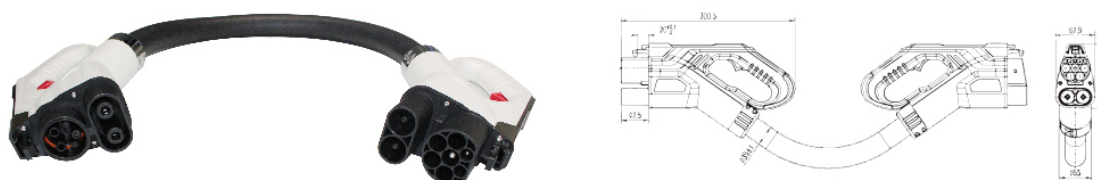

产品特点 Features

- 符合 IEC 62196-3: 2014 标准
Comply with IEC 62196-3: 2014 standards
- 外形美观, 手持式设计符合人体工程学原理, 插拔便捷
Nice appearance, hand-held ergonomic design, easy plug

机械性能 Mechanical properties

- 机械寿命: 空载拔插 > 10000 次
Mechanical life: no load > unplug and plug 10000 times

环境性能 Environmental performance

- 工作环境温度: -30°C ~ +50°C
Operating temperature: -30°C ~ +50°C

材料应用 Applied Materials

- 外壳材料: 热塑性塑料
Case Material: Thermoplastic
- 端子: 铜合金, 表面镀银
Terminal: copper alloy, silver plated surface
- 内芯: 热塑性塑料
Inner core: thermoplastic
- 优越的防护性能, 防护等级达到 IP54 (工作状态)
Excellent protection performance, protection grade IP54 (working condition)

电气性能 Electrical Performance

- 额定工作电流: 150A
Rated operating current: 150A
- 工作电压: 1000V DC
Operating voltage: 1000V DC
- 绝缘电阻: > 5M Ω (DC500V)
Insulation resistance: 5 m or more Ω (DC500V)
- 端子温升: < 50K
Terminal temperature rise: < 50K
- 耐压: 2000V AC/1min
Pressure resistance: 2000V AC/1min
- 接触阻抗: 0.5 m Ω Max
Contact resistance: 0.5 m Ω Max

产品选型与标准配线 Model selection and the standard wiring

型号 / Model	额定电流 / Rated current	线缆规格 / Cable specification
35125	150A	1AWG*2C+6AWG*1C+20AWG*6C

Adapter

产品应用:电动汽车端电连接输出
Product application:Electric vehicle electrical connection

型号 Model:
● 20530

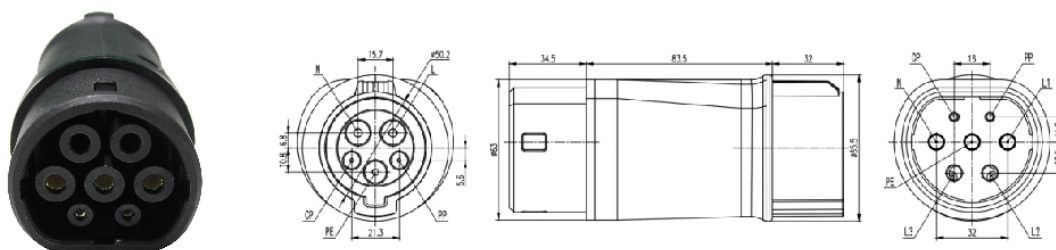

产品特点 Features

- 符合 IEC 62196-2 和 SAE J1772 2010 标准
Comply with IEC 62196-2 and SAE J1772 2010 standards

机械性能 Mechanical properties

- 机械寿命: 空载拔插 > 10000 次
Mechanical life: no load > unplug and plug 10000 times

环境性能 Environmental performance

- 工作环境温度: -30°C~+50°C
Operating temperature: -30°C~+50°C

材料应用 Applied Materials

- 外壳材料: 热塑性塑料, 阻燃等级 UL94 V-0
Case Material: thermoplastic, flame retardant grade UL94 V-0
- 端子: 铜合金, 表面镀银
Terminal: copper alloy, silver plated surface
- 优越的防护性能, 防护等级达到: IP23
Excellent protection performance, protection grade: IP23

电气性能 Electrical Performance

- 额定工作电流: 32A
Rated operating current: 32A
- 工作电压: 250V AC
Operating voltage: 250V AC
- 绝缘电阻: >10MΩ (DC 500V)
Insulation resistance: > 10 mΩ (DC 500 v)
- 端子温升: <50K
Terminal temperature rise: < 50K
- 接触阻抗: 0.5 mΩ Max
Contact resistance: 0.5 mΩ Max

电动机车(ES)高低压充电插头

产品应用:电动汽车端电连接输入
Product application:Electric vehicle electrical connection

型号 Model:

● RHTEC-ES-60P

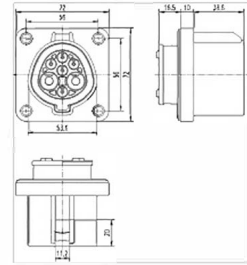
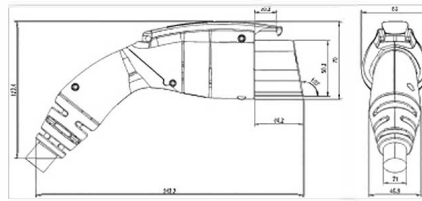

产品特点 Features

- 符合 IEC 62196-6 ED1 标准

Comply with IEC 62196-6 ED1 standard

机械性能 Mechanical properties

- 机械寿命: 空载插拔 > 10000 次

Mechanical life: no load plug > 10000 times

环境性能 Environmental performance

- 工作环境温度: -30°C~+50°C

Operating temperature: -30°C~+50°C

材料应用 Applied Materials

- 外壳材料: 热塑性塑料, 阻燃等级 UL94 V-0
Case Material: thermoplastic, flame retardant grade UL94 V-0

- 端子: 铜合金, 表面镀银

Terminal: copper alloy, silver plated surface

- 内盖 / 后盖板: 热塑性塑料

Inner cover/back cover: thermoplastic

- 优越的防护性能, 防护等级达到 IP54 (工作状态)

Excellent protection performance, protection grade IP54 (working condition)

- 外形美观, 手持式设计符合人体工程学原理, 插拔便捷

Nice appearance, hand-held ergonomic design, easy plug

电气性能 Electrical Performance

- 额定工作电流: 60A

Rated operating current: 60A

- 工作电压: 120V DC

Operating voltage: 120V DC

- 绝缘电阻: $\geq 5M\Omega$ (DC500V)

Insulation resistance: 5 m or more Ω (DC500V)

- 端子温升: < 50K

Terminal temperature rise: < 50K

- 耐电压: 2000V AC/1min

Voltage resistance: 2000V AC/1min

- 接触电阻: 0.5 m Ω Max

Contact resistance: 0.5 m Ω Max

产品选型与标准配线 Model selection and the standard wiring

型号 /Model	额定电流 /Rated current	线缆规格 /Cable specification
RHTEC-ES-60P	60A /120V DC	2*10mm ² +8*0.75mm ² +4*0.75mm ²

YGB-106 放电插座

产品应用:电动汽车端电连接输入
Product application:Electric vehicle electrical connection

型号 Model:
● YGB-106

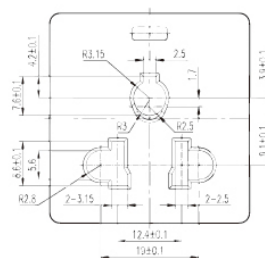

产品特点 Features

- 插座结构尺寸需与以下标准插头适配:
The structure and size of the socket shall be compatible with the following standard plugs:
- 中国: GB 1002-2008 美国: NEMA 5-15 日本: JSAC 8303:2007
China: GB 1002-2008 Us: NEMA 5-15 Japan: JSA C 8303:2007
- 澳大利亚 巴西 欧洲
Australia Brazil Europe
- 外形简洁,支持后安装
Concise appearance, support front and back installation

机械性能 Mechanical properties

- 机械寿命: 空载插拔>20000 次
Mechanical life: no load > unplug and plug 20000 times

环境性能 Environmental performance

- 工作环境温度: -30°C~+50°C
Operating temperature: -30°C~+50°C

材料应用 Applied Materials

- 外壳材料: 热塑性塑料,阻燃等级 UL94 V-0
Case Material: thermoplastic, flame retardant grade UL94 V-0
- 端子: 铜合金,表面酸洗
Terminal: Copper alloy, surface pickling

电气性能 Electrical Performance

- 额定工作电流: 10A
Rated operating current: 10A
- 工作电压: 220V AC
Operating voltage: 220V AC
- 绝缘电阻: $\geq 5\text{M}\Omega$ (DC500V)
Insulation resistance: 5 m or more Ω (DC500V)
- 插套温升: <45K
Terminal temperature rise: < 45K
- 耐压: 2000V AC/1min
Pressure resistance: 2000V AC/1min
- 接触电阻: 3 m Ω Max
Contact resistance: 3m Ω Max

YGP-179

韩标充电插头V2

产品应用:电动汽车端电连接输入
Product application:Electric vehicle electrical connection

型号 Model:
● YGP-179



产品特点 Features

- 插头尺寸需与韩标插电插座适配,充电枪身长度小于 90mm
The size of the plug shall be compatible with the Korean standard plug, and the length of the charging gun shall be less than 90mm
- 外形美观,手持式设计符合人体工程学原理,插拔便捷
Nice appearance, hand-held ergonomic design, easy plug

机械性能 Mechanical properties

- 机械寿命: 空载插拔 > 10000 次
Mechanical life: no load plug > 10000 times

环境性能 Environmental performance

- 工作环境温度: -20°C~+50°C
Operating temperature: -20°C~+50°C

材料应用 Applied Materials

- 壳体: PC/PBT 357U 米白色
Housing: PC/PBT 357U rice white
- 端子: 铜合金,表面镀银
Terminal: copper alloy, silver plated surface
- 优越的防护性能,防护等级达到 IP54(工作状态)
EXcellent protection performance, protection grade IP54 (working condition)

电气性能 Electrical Performance

- 额定工作电流: 32A
Rated operating current: 32A
- 工作电压: 220V AC
Working voltage: 220V/ AC
- 绝缘电阻: $\geq 1000\text{M}\Omega$ (DC500V)
Insulation resistance: > 1000 m Ω (DC500V)
- 插套温升: <50K
Socket temperature rise: < 50K
- 耐压: 2000V AC/1min
Withstand voltage: 2000V AC/1min
- 接触电阻: 5 m Ω Max
Contact resistance: 5 m Ω Max

产品选型与标准配线 Model selection and the standard wiring

型号 /Model	额定电流 /Rated current	线缆规格 /Cable specification
YGP-179	32A	3*6mm ² +2*0.5mm ² TUV/TPU

电动机车(ES)高低压充电插座

产品应用:电动汽车端电连接输入
Product application:Electric vehicle electrical connection

型号 Model:
● RHTEC-ES-60S

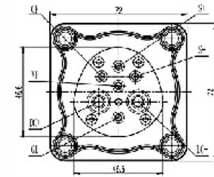
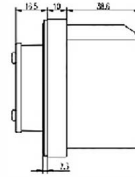
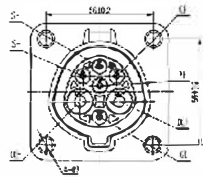

产品特点 Features

- 符合 IEC 62196-6 ED1 标准
Comply with IEC 62196-6 ED1 standards

机械性能 Mechanical properties

- 机械寿命: 空载插拔 > 10000 次
Mechanical life: no load plug > 10000 times

环境性能 Environmental performance

- 工作环境温度: -30°C~+50°C
Operating temperature: -30°C~+50°C

材料应用 Applied Materials

- 外壳材料: 热塑性塑料, 阻燃等级 UL94 V-0
Case Material: thermoplastic, flame retardant grade UL94 V-0
- 端子: 铜合金, 表面镀银
Terminal: copper alloy, silver plated surface
- 优越的防护性能, 防护等级达到 IP54 (工作状态)
Excellent protection performance, protection grade IP54 (working condition)

电气性能 Electrical Performance

- 额定工作电流: 60A
Rated operating current: 60A
- 工作电压: 120V DC
Operating voltage: 120V DC
- 绝缘电阻: $\geq 5M\Omega$ (DC500V)
Insulation resistance: 5 m or more Ω (DC500V)
- 端子温升: < 50K
Terminal temperature rise: < 50K
- 耐电压: 2000V AC/1min
Voltage resistance: 2000V AC/1min
- 接触电阻: 0.5 m Ω Max
Contact resistance: 0.5 m Ω Max

产品选型与标准配线 Model selection and the standard wiring

型号 /Model	额定电流 /Rated current	线缆规格 /Cable specification
RHTEC-ES-60S	60A/120V DC	单导线 10mm ² *2、0.75mm ² *8

日标直流充电插座

产品应用: 电动汽车端电连接输入
Product application: Electric vehicle electrical connection

型号 Model:
● RHTEC3a-G-EV-S

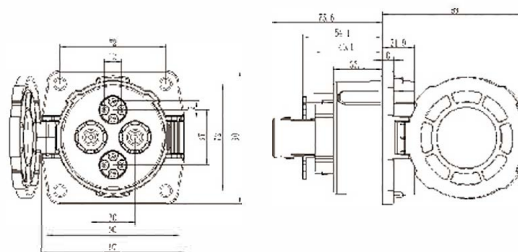

产品特点 Features

- 符合 IEC 62196-3:2014 标准
Comply with IEC 62196-3: 2014 standards

机械性能 Mechanical properties

- 机械寿命: 空载拔插 > 10000 次
Mechanical life: no load > unplug and plug 10000 times

环境性能 Environmental performance

- 工作环境温度: -30°C~+50°C
Operating temperature: -30°C~+50°C

材料应用 Applied Materials

- 座壳: 铝合金
Base case: aluminum alloy
- 端子: 铜合金, 表面镀银
Terminal: copper alloy, silver plated surface
- 内芯: 热塑性塑料
Inner core: thermoplastic
- 优越的防护性能, 防护等级达到 IP54
Excellent protection performance, protection grade IP54

- 外形美观, 带防护盖, 支持前安装方式
Nice appearance, hand-held ergonomic design, easy plug

电气性能 Electrical Performance

- 额定工作电流: 200A/150A/125A
Rated working current: 200A/150A/125A
- 工作电压: 600V DC
Working voltage: 600V DC
- 绝缘电阻: >2000MΩ(DC1000V)
Insulation resistance: > 2000 m Ω (DC1000V)
- 端子升温: <50K
Terminal temperature rise: < 50K
- 耐电: 3000V/DC
Electrical resistance: 3000 v/DC
- 接触电阻: 0.5mΩ Max
Contact resistance: 0.5 m Ω Max

产品选型与标准配线 Model selection and the standard wiring

型号 /Model	额定电流 /Rated current	线缆规格 /Cable specification
RHTEC3a-G-EV125S	125A	2*35mm ² +7*0.75mm ²
RHTEC3a-G-EV150S	150A	2*50mm ² +7*0.75mm ²
RHTEC3a-G-EV200S	200A	2*70mm ² +7*0.75mm ²

Adapter

产品应用:电动汽车端电连接输出
Product application:Electric vehicle electrical connection

型号 Model:
● V2L-10

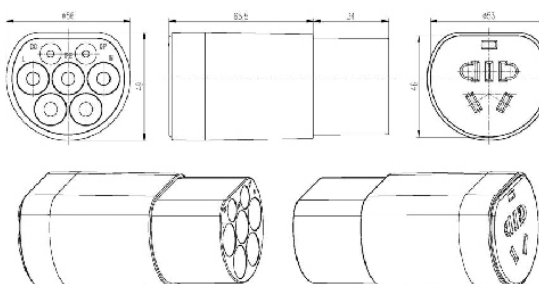

产品特点 Features

- 国标插头端: 按 GB/T 20234.2-2015 电动汽车传导充电用连接装置
GB plug end: according to GB/T 20234.2-2015 ELECTRIC vehicle conduction charging connection device
- 放电插座端: 10A 五孔插座面板孔位尺寸按 GB1002-2008 标准执行
Discharge socket end: 10A five-hole socket panel hole size according to GB1002-2008 standard

机械性能 Mechanical properties

- 机械寿命: 国标插头端空载拔插 > 10000 次
Mechanical life: gb plug end unplug > 10000 times
- 放电插座端空载拔插 > 20000 次
Discharge socket end unplug > 20000 times

环境性能 Environmental performance

- 工作环境温度: -30°C~+50°C
Operating temperature: -30°C~+50°C

材料应用 Applied Materials

- 外壳材料: 热塑性塑料, 阻燃等级 UL94V-0
Case Material: thermoplastic, flame retardant grade UL94V-0
- 端子: 铜合金, 表面镀银
Terminal: copper alloy, silver plated surface
- 优越的防护性能, 国标插头端插合状态下防护等级: IP54
Excellent protection performance, gb plug end plugged in state of protection grade: IP54

- 第 2 部分: 交流充电接口
Part 2: ALTERNATING current charging interface
- 当插入与之适配的插头时防触门滑动而触发开关输出 CC 阻值使逆变器工作提供电源后通过本插座向外放电
When the fitting plug is inserted, the anti-contact door slides and the trigger switch outputs CC resistance value so that the inverter can work and supply power and then discharge outward through the socket

电气性能 Electrical Performance

- 额定工作电流: 10A
Rated operating current: 10A
- 工作电压: 220V AC
Operating voltage: 220V AC
- 绝缘电阻: $\geq 5\text{M}\Omega$ (DC500V)
Insulation resistance: 5 m or more Ω (DC500V)
- 国标插头端端子温升: < 50K
Gb plug terminal temperature rise: < 50K
- 放电插座端插套温升: < 45K
Discharge socket temperature rise: < 45K
- 耐压: 2000V AC/1min
Pressure resistance: 2000V AC/1min
- 接触阻抗: 10 m Ω Max
Contact resistance: 10 m Ω Max

COMBO 1

产品应用: 电动汽车端电连接输入
Product application: Electric vehicle electrical connection

型号 Model:

● V2-RHTEC3j-G-EVXXSXX

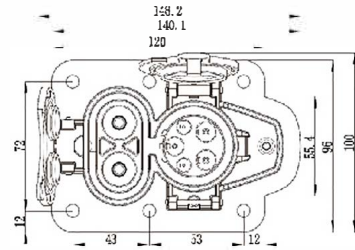
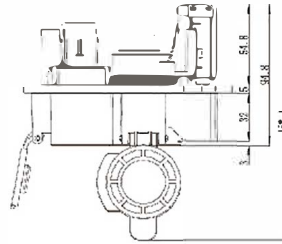

快速代码 Speed code: 3530

产品特点 Features

- 充电插座符合 SAE J1772-2016 标准
Charging socket conforms to SAE J1772-2016 standard
- 外形简洁, 支持前后安装方式
Concise appearance, support front and back installation
- 插针头部采用安全绝缘设计, 防止人手意外直接接触
Safety pins insulated head design to prevent accidental direct contact with staff

机械性能 Mechanical properties

- 机械寿命: 空载拔插 > 10000 次
Mechanical life: no-load plug in/pull out > 10000 times

环境性能 Environmental performance

- 工作环境温度: -30°C ~ +50°C
Operating temperature: -30°C ~ +50°C

材料应用 Applied Materials

- 外壳材料: 热塑性塑料, 阻燃等级 UL94 V-0
Case Material: Thermoplastic, flame retardant grade UL94 V-0
- 插针: 铜合金, 表面镀银 + 顶部热塑性塑料
Pin: Copper alloy, silver + thermoplastic on the top

- 产品整体防护等级 3S
Overall product protection level 3S
- 背面防护等级 IP65
Back protection class IP65

电气性能 Electrical Performance

- 直流输入: 80A/150A/200A 600V DC
DC input: 80A/150A/200A 600VDC
- 工交流输入: 16A/32A/60A 240/415V AC
AC input: 16A/32A/60A 240/415V AC
- 绝缘电阻: > 2000MΩ (DC500V)
Insulation resistance: > 2000MΩ (DC500V)
- 端子温升: < 50K
Terminal temperature rise: < 50K
- 耐压: 3000V
Withstand Voltage: 3000V
- 接触阻抗: 0.5mΩ Max
Contact Resistance: 0.5mΩ Max

产品选型与标准配线 Model selection and the standard wiring

型号 /Model	额定电流 /DC/AC	线缆规格 /Cable specification
V2-RHTEC3j-G-EV80S16	80A/16A	2×5AWG+1×8AWG+2×14AWG+2×20AWG
V2-RHTEC3j-G-EV80S32	80A/32A	2×5AWG+1×8AWG+2×10AWG+2×20AWG
V2-RHTEC3j-G-EV150S16	150A/16A	2×1AWG+1×6AWG+2×14AWG+2×20AWG
V2-RHTEC3j-G-EV150S32	150A/32A	2×1AWG+1×6AWG+2×10AWG+2×20AWG
V2-RHTEC3j-G-EV150S60	150A/60A	2×1AWG+1×6AWG+2×6AWG+2×20AWG
V2-RHTEC3j-G-EV200S16	200A/16A	2×2/0AWG+1×6AWG+2×14AWG+2×20AWG
V2-RHTEC3j-G-EV200S32	200A/32A	2×2/0AWG+1×6AWG+2×10AWG+2×20AWG
V2-RHTEC3j-G-EV200S60	200A/60A	2×2/0AWG+1×6AWG+2×6AWG+2×20AWG

Adapter

产品应用:电动汽车端电连接输出
Product application:Electric vehicle electrical connection

型号 Model:

● 40130

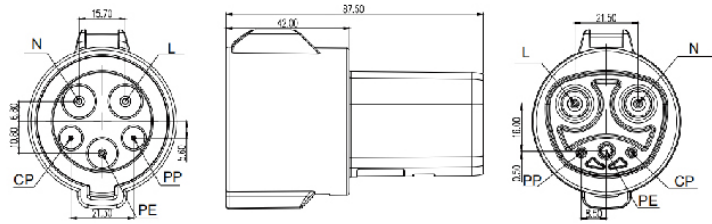

产品特点 Features

- 符合 SAE J1772 2010 标准
Comply with SAE J1772 2010 standard

机械性能 Mechanical properties

- 机械寿命: 空载插拔 > 10000 次
Mechanical life: no load plug > 10000 times

环境性能 Environmental performance

- 工作环境温度: -30°C~+50°C
Operating temperature: -30°C~+50°C

材料应用 Applied Materials

- 壳体: 热缩性塑料
Case Material: thermoplastic
- 端子: 铜合金、表面镀银
Terminal: copper alloy, silver plated surface
- 优越的防护性能, 转接头防护等级达到: IP54 (耦合状态)
Excellent protection performance, adapter protection grade: IP54 (coupling state)

电气性能 Electrical Performance

- 额定工作电流: 60A
Rated operating current: 60A
- 工作电压: 250V AC
Operating voltage: 250V AC
- 绝缘电阻: $\geq 5M\Omega$ (DC500V)
Insulation resistance: 5 m or more Ω (DC500V)
- 端子温升: < 50K
Terminal temperature rise: < 50K
- 耐压: 2000V AC/min
Voltage resistance: 2000V AC/min
- 接触电阻: 0.5 m Ω Max
Contact resistance: 0.5 m Ω Max

CHARGING MOOE 2 集成式充电模式2

产品应用:电动汽车端电连接输出
Product application:Electric vehicle electrical connection

型号 Model:

- 2080-IPSE-10-XC-ES
- 2080-IPSE-16-XC-ES
- 2080-IPSE-32-XC-ES

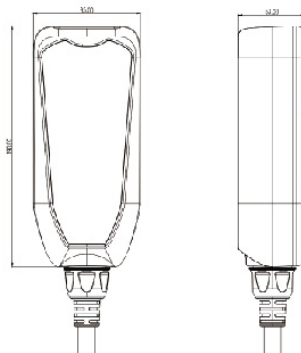

产品特点 Features

- 符合 IEC 62752:2016 标准

Comply with IEC 62752:2016 standard

机械性能 Mechanical properties

- 机械寿命: 空载拔插 > 10000 次

Mechanical life: no-load plug in/pull out > 10000 times

环境性能 Environmental performance

- 工作环境温度: -30°C~+50°C

Operating temperature: -30°C~+50°C

材料应用 Applied Materials

- 座壳: 铝合金

Base case: aluminum alloy

- 端子: 铜合金, 表面镀银

Terminal: copper alloy, silver plated surface

- 内芯: 热塑性塑料

Inner core: thermoplastic

- 优越的防护性能, 控制盒防护等级达到 IP67

Excellent protection performance, PSE IP67

电气性能 Electrical Performance

- 额定工作电流: 10/16/32A

Rated current: 10/16/32A

- 工作电压: 230V AC

Operating voltage: 230V AC

- 绝缘电阻: > 500MΩ (DC500V)

Insulation resistance: > 500 m Ω (DC500V)

- 耐电: 2000V/DC

Electrical resistance: 2000 v/DC

- 接触电阻: 0.5 mΩ Max

Contact resistance: 0.5 m Ω Max

- 海拔: 2000m

Height: 2000 m

- 漏电工作范围: 30mA

Working scope of leakage: 30mA

- 漏电流方式: A+6mA

Leakage current mode: A+6mA

- 短路限制电流: 1.5KA

Short circuit limiting current: 1.5ka

产品选型与标准配线 Model selection and the standard wiring

型号 /Model	额定电流 /DC/AC	线缆规格 /Cable specification
2080-IPSE-10-XC-ES	10A	3*6mm ² +1*0.75mm ²
2080-IPSE-16-XC-ES	16A	3*6mm ² +1*0.75mm ²
2080-IPSE-32-XC-ES	32A	3*6mm ² +1*0.75mm ²

交流充电插座

产品应用: 电动汽车端电连接输入
Product application: Electric vehicle electrical connection

型号 Model:

● V3-RHTEC2a-GEL-EV16S/32S/50S/63S

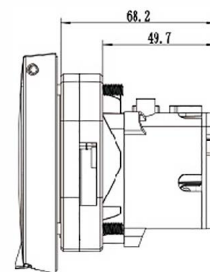
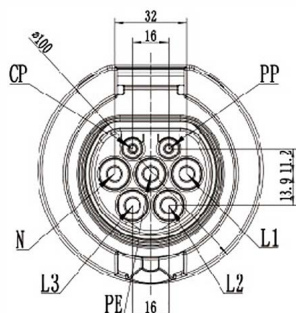

产品特点 Features

- 符合 IEC 62196-2: 2010 标准
Comply with IEC 62196-2:2010 standard
- 外形美观, 带保护门, 带防护盖, 支持后安装方式
Nice appearance, with protective door, with protective cover, support after installation

机械性能 Mechanical properties

- 机械寿命: 空载拔插 > 10000 次
Mechanical life: no-load plug in/pull out > 10000 times

环境性能 Environmental performance

- 工作环境温度: -30°C ~ +50°C
Operating temperature: -30°C ~ +50°C

材料应用 Applied Materials

- 座壳: 热塑性材料
Case Material: Thermoplastic materials
- 端子: 铜合金, 表面镀银
Terminal: copper alloy, silver plated
- 内芯: 热塑性塑料
Inner core: thermoplastic
- 优越的防护性能, 防护等级达到 IP55 (插合后)
Superior protection performance, protection level up to IP55 (after insertion)

电气性能 Electrical Performance

- 额定工作电流: 32A
Rated current: 32A
- 工作电压: 250/415VAC
Operation voltage: 250/415V AC
- 绝缘电阻: > 1000MΩ (DC500V)
Insulation resistance: > 1000 mΩ (DC500V)
- 端子升温: < 50K
Terminal temperature rise: < 50K
- 耐电: 2000V/DC
Electrical resistance: 2000 v/DC
- 接触电阻: 0.5 mΩ Max
Contact Resistance: 0.5 mΩ Max

产品选型与标准配线 Model selection and the standard wiring

型号 /Model	额定电流 /DC/AC	线缆规格 /Cable specification
V3-RHTEC2a-GEL-EV16S	16A 单相	3*2.5mm ² +2*0.75mm ²
V3-RHTEC2a-GEL-EV16S-3	16A 三相	5*2.5mm ² +2*0.75mm ²
V3-RHTEC2a-GEL-EV32S	32A 单相	3*6mm ² +2*0.75mm ²
V3-RHTEC2a-GEL-EV32S-3	32A 三相	5*6mm ² +2*0.75mm ²
V3-RHTEC2a-GEL-EV50S	50A 单相	3*10mm ² +2*0.75mm ²
RHTEC2a-GEL-EV50S-3V3-	50A 三相	5*10mm ² +2*0.75mm ²
RHTEC2a-GEL-EV63S	63A 单相	3*16mm ² +2*0.75mm ²
V3-RHTEC2a-GEL-EV63S-3	63A 三相	5*16mm ² +2*0.75mm ²

CHARGING MOOE 3 CHARGING PILE

充电模式3 充电桩

产品应用:电动汽车端电连接输入
Product application:Electric vehicle electrical connection

型号 Model:

● SEL



技术规格 Technical specifications

- 安装方式: 立柱式/壁挂式
Installation mode: pile-mounted/wall-mounted
- 最大功率: 22KW/11KW
Maximum power: 22KW/11KW
- 通信接口: (选配) WIFI 4G
Communication interface :(optional) WIFI 4G
- 室外防护: 未通电 - 防护等级可达 IP55
通电 - 枪头耦合状态防护等级可达 IP54
Outdoor protection: no power on - protection level up to IP55
The protection class of energized - muzzle coupling state is up to IP54
- 安全规范: 符合 IEC 61851 标准
Safety specification: Comply with IEC 61851 standard
- 工作温度: 环境温度 -30°C到 50°C
Operating temperature: ambient temperature from -30°C to 50°C
- 自测试功能: 故障自定位(联网产品后台可以看到)
Self-test function: Fault self-location (you can see it in the background of networked products)
- 人机交互: 选配 LCD 8 寸/5 寸 无屏
Human-computer interaction: Optional LCD 8 "/5" no screen

基本尺寸要求 Basic size requirement

- 输入端线缆长度: 1 米
Length of input cable: 1m

安全防护 Security

- 双重漏电检测与保护
Dual leakage detection and protection
- 急停按钮防护
Emergency stop button protection
- 过流、过压、欠压、过温度保护
Over current, over pressure, under pressure, over temperature protection
- 断电数据记录(联网产品后台可以看到)
Data recording of power outage (can be seen in the background of networked products)
- 浪涌保护符合最新 IEC 61851 标准
Surge protection complies with the latest IEC 61851 standards
- 电磁兼容符合最新 IEC 61851
Electromagnetic compatibility conforms to the latest IEC 61851

输出类型 Output type

- IEC 62196 Type2/Type3
- 22KW: 400VAC@ 32A
- 11KW: 400VAC@ 16A

基本功能 Basic skills

- 启动方式: 即插即充
Start mode: plug and charge
- 选配: RFID 卡 WIFI (Smart charge)
Optional: RFID card WIFI (Smart charge)
- 提醒功能: 充电指示、故障指示
Reminder function: charging indication, fault indication

CHARGING MODE 3 CHARGING PILE

充电模式3 充电桩

产品应用:电动汽车端电连接输入
Product application:Electric vehicle electrical connection

型号 Model:

● SES



技术规格 Technical specifications

- 安装方式: 立柱式 / 壁挂式
Installation mode: pile-mounted/wall-mounted
- 最大功率: 22KW/11KW
Maximum power: 22KW/11KW
- 通信接口: 选配 WIFI 4G
Communication interface :(optional) WIFI 4G
- 室外防护: 未通电 - 防护等级可达 IP55
通电 - 枪头耦合状态防护等级可达 IP54
Outdoor protection: no power on - protection level up to IP55
The protection class of energized - muzzle coupling state is up to IP54
- 安全规范: 符合 IEC 61851 标准
Safety specification: Comply with IEC 61851 standard
- 工作温度: 环境温度 -30°C到 50°C
Operating temperature: ambient temperature from -30°C to 50°C
- 自测试功能: 故障自定位(联网产品后台可以看到)
Self-test function: Fault self-location (you can see it in the background of networked products)
- 人机交互: 选配 LED 屏
Human-computer interaction: Equipped with LED screen

基本尺寸要求 Basic size requirement

- 输入端线缆长度: 1 米
Length of input cable: 1m

安全防护 Security

- 安全规范: 符合 IEC 61851 标准
Safety specification: Comply with IEC 61851 standard
- 工作温度: 环境温度 -30°C到 50°C
Operating temperature: ambient temperature from -30°C to 50°C
- 输出类型 Output type
 - IEC 62196 Type2/Type3
 - 22KW: 400VAC@ 32A
 - 11KW: 400VAC@ 16A
- 基本功能 Basic skills
 - 启动方式: 即插即充
Start mode: plug and charge
 - 选配: RFID 卡 WIFI (Smart charge)
Optional: RFID card
 - 提醒功能: 充电指示、故障指示
Reminder function: charging indication, fault indication
- 急停按钮防护
Emergency stop button protection
- 过流、过压、欠压、过温度保护
Over current, over pressure, under pressure, over temperature protection
- 断电数据记录(联网产品后台可以看到)
Data recording of power outage (can be seen in the background of networked products)
- 浪涌保护符合最新 IEC 61851 标准
Surge protection complies with the latest IEC 61851 standards
- 电磁兼容符合最新 IEC 61851
Electromagnetic compatibility conforms to the latest IEC 61851

直流充电插头

型号 Model:

- V5-RHT-EV-80P
- V5-RHT-EV-125P
- V5-RHT-EV-200P
- V5-RHT-EV-250P

产品应用: 电动汽车端电连接输入

Product application: Electric vehicle electrical connection

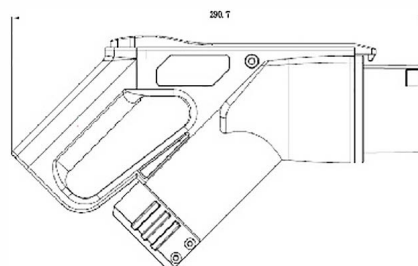
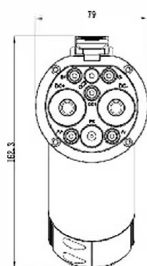

产品特点 Features

- 符合 GB/T20234 标准
Meet GB/T20234 standard
- 外型美观, 手持式设计符合人体工程学原理, 插拔便捷
Nice appearance, hand-ergonomic design, easy plug

机械性能 Mechanical properties

- 机械寿命: 空载插拔 > 10000 次
Mechanical life: no-load plug in/pull out > 10000 times

环境性能 Environmental performance

- 工作环境温度: -30°C~+50°C
Operating temperature: -30°C~+50°C

材料应用 Applied Materials

- 外壳: 热塑性塑料
Case: Thermoplastic
- 端子: 铜合金, 表面镀银
Terminal: copper alloy, silver plated surface

- 内芯: 热塑性塑料
Inner core: thermoplastic

- 防水等级: IP55 (整体) 电锁 IP67
Waterproof grade: IP55 (integral) electric lock IP67

电气性能 Electrical Performance

- 额定工作电流: 80A/125A/150A/200A/250A
Rated working current: 80A/125A/150A/200A/250A
- 工作电压: 1000VDC
Operating voltage: 1000V DC
- 绝缘电阻: >1000MΩ (DC500V)
Insulation resistance: > 1000 mΩ (DC500V)
- 端子升温: <50K
Terminal temperature rise: < 50K
- 耐电: 3000V/DC
Electrical resistance: 3000 v/DC
- 接触电阻: 0.5 mΩ Max
Contact resistance: 0.5 mΩ Max

产品选型与标准配线 Model selection and the standard wiring

型号 /Model	额定电流 /DC/AC	线缆规格 /Cable specification
V5-RHT- EV80P	80A	3×1.6mm ² +2×4mm ² +2P(4×0.75mm ²)+2P(2×0.75mm ²)
V5-RHT- EV125P	100A	2×25mm ² +1×16mm ² +2×4mm ² +2P(4×0.75mm ²)+2P(2×0.75mm ²)
	125A	2×35mm ² +1×16mm ² +2×4mm ² +2P(4×0.75mm ²)+2P(2×0.75mm ²)
V5-RHT- EV200P	150A	2×50mm ² +1×25mm ² +2×4mm ² +2P(4×0.75mm ²)+2P(2×0.75mm ²)
	200A	2×70mm ² +1×25mm ² +2×4mm ² +2P(4×0.75mm ²)+2P(2×0.75mm ²)
V5-RHT- EV250P	250A	2×80mm ² +1×25mm ² +2×4mm ² +2P(4×0.75mm ²)+2P(2×0.75mm ²)

CHARGING MOOE 2

充电模式2

产品应用: 电动汽车端电连接输入
Product application: Electric vehicle electrical connection

型号 Model:
2080-PSE-32-XC-ES-3

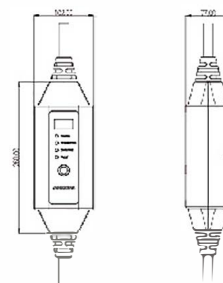

产品特点 Features

- 符合 IEC 62196-3: 2014 标准
Comply with IEC 62196-3:2014 standard
外形美观, 带防护盖, 支持前安装方式
Beautiful appearance, with protective cover, support before installation

机械性能 Mechanical properties

- 机械寿命: 空载拔插 > 10000 次
Mechanical life: no-load plug in/pull out > 10000 times

环境性能 Environmental performance

- 工作环境温度: -30°C ~ +50°C
Operating temperature: -30°C ~ +50°C

材料应用 Applied Materials

- 材料: PC10FRN
Material: PC10FRN
- 端子: 铜合金, 表面镀银
Terminal: copper alloy, silver plated surface
- 优越的防护性能, 防护等级达到 IP66
Excellent protection performance, protection grade IP66

电气性能 Electrical Performance

- 额定工作电流: 32A
Rated operating current: 32A
- 工作电压: 230/400VAC
Operating voltage: 230/400VAC
- 绝缘电阻: > 1000MΩ (DC500V)
Insulation resistance: > 1000 m.Ω (DC500V)
- 端子温升: < 50K
Terminal temperature rise: < 50K
- 耐电: 2000V/DC
Electrical resistance: 2000 v/DC

产品选型与标准配线 Model selection and the standard wiring

型号 / Model	额定电流 / DC/AC	线缆规格 / Cable specification
2080-PSE-32-XC-ES-3	32A	5*6mm ² +1*0.75mm ²